

TABELLA PREZZI FINITURE	pag. 120
INFO TECNICHE	pag. 120
ESEMPI COMPOSIZIONI DOCCIA	pag. 122
INDICE / INDEX	pag. 123
SUPPORTI DOCCIA	pag. 132
DOCCETTE MULTIFUNZIONE	pag. 138
SUPPORTI DOCCIA PER BORDO VASCA	pag. 139
SALISCENDI	pag. 140
STELI CON PRESE D'ACQUA	pag. 149
ACCESSORI PER SALISCENDI E STELI	pag. 153
NEBULIZZATORI BODY JET	pag. 153
SCARICHI DOCCIA	pag. 155
GANCI ESTERNI DUPLEX	pag. 156
ACCESSORI PULIZIA	pag. 157

PREZZO FINITURE

Calcola il prezzo di listino (IVA esclusa) delle finiture diverse dal cromato, consultando la seguente tabella.

Moltiplicare il **PREZZO LISTINO** per il **COEFFICIENTE MOLTIPLICATORE** della finitura scelta, arrotondando per difetto il prezzo ottenuto (eliminare i centesimi).
ESEMPIO per ordinare art. 0303/1K/A in finitura dorato: codice 04-0303/1K/A

€ 148,00 (PREZZO LISTINO) x 2,20 (MOLTIPLICATORE) = € ~~325,60~~ 325,00

PRICE FINISHES

Include the list price (excluding VAT) of different finishes from chrome, consulting the following table. Multiply the **PRICE LIST MULTIPLIER COEFFICIENT** of the chosen finish, reducing the price obtained by deleting the centesim.

EXAMPLE to order art. 0303/1K/A gold finish: code 04-0303/1K/A

€ 148,00 (LIST PRICE) x 2,20 (MULTIPLIER) = € ~~325,60~~ 325,00

COMPOSIZIONE CODICE PER ORDINARE ARTICOLO IN FINITURA



CODICE FINITURA
FINISH CODE

CODICE ARTICOLO
ITEM NUMBER

FINITURE REALIZZABILI

CODICE CODE	DESCRIZIONE FINITURA FINISH DESCRIPTION	GRUPPO A	GRUPPO B	GRUPPO C	GRUPPO D	GRUPPO E	GRUPPO F
01-	cromato / chrome	PREZZO LISTINO°	PREZZO LISTINO°	PREZZO LISTINO°	PREZZO LISTINO°	PREZZO LISTINO°	N.R.
02-	cromo/oro / chrome/gold	x	x	x	x	N.R.	N.R.
03-	oro/argento / gold/silver	x	x	x	x	N.R.	N.R.
04-	dorato / gold	x	x	x	x	N.R.	N.R.
05-	bronzo satinato / satin bronze	N.R.	x	x	x	N.R.	N.R.
06-	rame vecchio / old copper	N.R.	x	x	x	N.R.	N.R.
07-	vecchio argento / old silver	x	x	x	x	N.R.	N.R.
08-	canna di fucile / gun barrel	N.R.	x	x	x	N.R.	N.R.
10-	verderame / verdigris	N.R.	x	x	x	N.R.	N.R.
11-	nero antracite / anthracite black	N.R.	N.R.	x	x	N.R.	N.R.
12-	ottone lucido / polished brass	N.R.	N.R.	x	x	N.R.	N.R.
13-	ottone naturale / natural brass	N.R.	N.R.	x	x	N.R.	N.R.
14-	bianco / white	x	x	x	x	N.R.	N.R.
19-	nero / black	x	x	x	x	N.R.	N.R.
28-	nickel satinato / satin nickel	N.R.	x	x	x	N.R.	N.R.
30-	nickel lucido / polished nickel	N.R.	x	x	x	N.R.	N.R.
33-	cromo satinato / satin chrome	N.R.	x	x	x	N.R.	N.R.
34-	cromo spazzolato / brushing chrome	N.R.	x	x	x	N.R.	N.R.
35-	nickel spazzolato / brushing nickel	N.R.	x	x	x	N.R.	N.R.
56-	avorio / ivory	N.R.	N.R.	x	x	N.R.	N.R.
57-	azzurro / light blue	N.R.	N.R.	x	x	N.R.	N.R.
58-	verdino / light green	N.R.	N.R.	x	x	N.R.	N.R.
59-	marrone / brown	N.R.	N.R.	x	x	N.R.	N.R.
60-	arancio / orange	N.R.	N.R.	x	x	N.R.	N.R.
61-	rosso / red	N.R.	N.R.	x	x	N.R.	N.R.
66-	bianco opaco / mat white	x	x	x	x	N.R.	N.R.
67-	nero opaco / mat black	x	x	x	x	N.R.	N.R.
68-	rame opaco / mat copper	N.R.	x	x	x	N.R.	N.R.
69-	argento opaco / mat silver	N.R.	x	x	x	N.R.	N.R.
71-	oro opaco / mat gold	N.R.	x	x	x	N.R.	N.R.
72-	bronzo opaco / mat bronze	N.R.	x	x	x	N.R.	N.R.
75-	dorato spazzolato / brushing gold	x	x	x	x	N.R.	N.R.
77-	inox 316 spazzolato	N.R.	N.R.	N.R.	N.R.	N.R.	PREZZO LISTINO°
87-	oro rosa / pink gold	x	x	x	x	N.R.	N.R.
88-	ottone sisal / sisal brass	N.R.	N.R.	x	x	N.R.	N.R.



PROGETTO SU MISURA: RICHIESTE SPECIALI

I tecnici di Bellosta Rubinetterie sono, inoltre, a disposizione di architetti e designers, per offrire un servizio esclusivo: personalizzazioni di elementi in funzione di specifiche richieste estetiche o problematiche legate a vincoli progettuali, verifica della fattibilità attraverso opportuni studi CAD e sviluppo del disegno tecnico del prodotto speciale richiesto.

Per informazioni e richieste PROGETTI SU MISURA:
ufficiotecnico@bellostarubinetterie.com



progetto
sumisura

PROGETTO SU MISURA: SPECIAL REQUESTS

Engineers Bellosta Rubinetterie are also available to architects and designers, to offer an exclusive service: customizations of items according to specific aesthetic requirements or issues related to design constraints, verification of the feasibility studies and development through appropriate CAD technical design the required special product. For information and requests "SU MISURA" PROJECTS:
ufficiotecnico@bellostarubinetterie.com

ELENCO ARTICOLI SUDDIVISI PER REALIZZABILITA' FINITURE:

GRUPPO A 0403/1/B, 0403/1/C, 3503/1, 5503/1/A, 5503/1, 3563, 5530.

GRUPPO B 1403/1/A, 6003/1, 9103/1/A, 9103/1, 1430, 1630, 1730, 1830, 9130, 8030/1, 8330/1, 9113/5/1/SP, 7716/E, 8816/E, 8016/E.

GRUPPO C 0303/1/A, 0303/1/A/LL, 0303/1K/A, 0303/1K/A/LL, 0303/1, 0303/1/LL, 0803/1/A, 0803/1/A/LL, 0803/1K/A, 0803/1K/A/LL, 0803/1, 0803/1/LL, 6303/1/A, 084040, 084040/LL, 104036, 104036/LL, 0730, 0830, 0830/L, 0830/LL, 1030, 1530, 1530/LL, 4030, 4030/B, 6330, 0530/1, 0830/1, 0830/1/L, 0830/1/LL, 0930/1, 1030/1, 1430/1, 1630/1, 1730/1, 1830/1, 3330/1, 4030/1, 4030/1/B, 6330/1, 6530/1, 7330/1, 8013/4, 8313/4, 0313/5/1, 0713/5/1, 0813/5/1, 0813/5/1/L, 0813/5/1/LL, 3313/5/1, 4013/5/1, 4013/5/1/B, 6313/5/1, 1015/S, 0514, 54112, 884067, 104038, 095001, 055116, 805001, 016, 014081, 035102, 144023, 445005, 655005, 804019.

GRUPPO D **PER I SEGUENTI ARTICOLI LE FINITURE DIVERSE DA CROMATO PREVEDONO DOCCETTA/SOFFIONE IN OTTONE INVECE DI ABS:**
0903/1/A, 0903/1, 3303/1/A, 3303/1, 4403/1/A, 4403/1, 6503/1/A, 6503/1, 8003/1/A*, 8003/1*, 044071, 654118, 0530, 0930, 3330, 6530, 7330, 8030*, 8330*, 0413/4/SP, 3313/4, 6513/4, 0413/5/1/SP, 0513/5/1, 6513/5/1.

* per finiture diverse da cromato, la doccetta è tonda invece di ovale

GRUPPO E 7503/1/A, 7503/1, 8603/1/A, 8603/1, 125089, 125090, 125091, 125094, 1230, 7530, 7730, 7930, 8630, 125074, 7730/1, 8030/1/A, 1213/5/1, 095039/E, 055251/E.

GRUPPO F 4503/1/A, 4503/1/AQ, 4530, 4530/1.

INSERTI

Gli inserti (impugnatura ed erogatore doccetta, leva saliscendi, etc.) della collezione BELLINI sono disponibili, **senza variazione di prezzo**, in:

INSERTS

Inserts (handle and hand shower, sliding lever, etc.) of BELLINI collection are available **without price change** in:



°PREZZO DI LISTINO / PRICE LIST

N.R. = NON REALIZZABILE / NOT MADE

ATTENZIONE! 13-OTTONE NATURALE e 88-OTTONE SISAL: finiture non protette che antichizzano naturalmente ossidando a contatto con l'umidità atmosferica.
WARNING! 13-NATURAL BRASS and 88-SISAL BRASS: unprotected finishes that naturally oxidise in contact with atmospheric humidity.

DATI TECNICI PER IMPIANTO IDRAULICO COLLEZIONE "SOFFIONI STANDARD"

Pressione minima di esercizio: 2 bar
 Pressione di esercizio - campo di impiego ottimale consigliato: 3÷4 bar
 Pressione massima di esercizio: 5 bar (Per pressioni idrauliche superiori si raccomanda l'installazione di un riduttore di pressione)
 Temperatura massima d'esercizio: 65°C
 Richiesto scarico a pavimento DN40 secondo la normativa europea EN274 (31 l/min con piatto doccia senza battente idraulico)

TECHNICAL DATA FOR HYDRAULIC PLANT "STANDARD CEILING" COLLECTION

Minimum pressure: 2 bar
 Pressure - optimal recommended use: 3÷4 bar
 Maximum pressure: 5 bar (for higher hydraulic pressure it is recommended a pressure reducer)
 Maximum temperature: 65°C
 Requested floor waste DN40 on the european law EN274 (31 l/min with flat shower without hydraulic batten)

Per il corretto funzionamento è consigliabile una pressione dinamica di almeno 1.5 bar ed una portata d'acqua di 10 lt/min. Scarico consigliato foro Ø90.
ATTENZIONE: per questa combinazione è necessario uno spessore minimo della parete di almeno mm 80.

For the correct function it's suggest to have a dynamic pressure not less than 1.5 bar and a water flow about 10 lt/min. Suggest waste hole Ø90
PAY ATTENTION: For this featuring is necessary a minimum wall depth not less than mm 80.

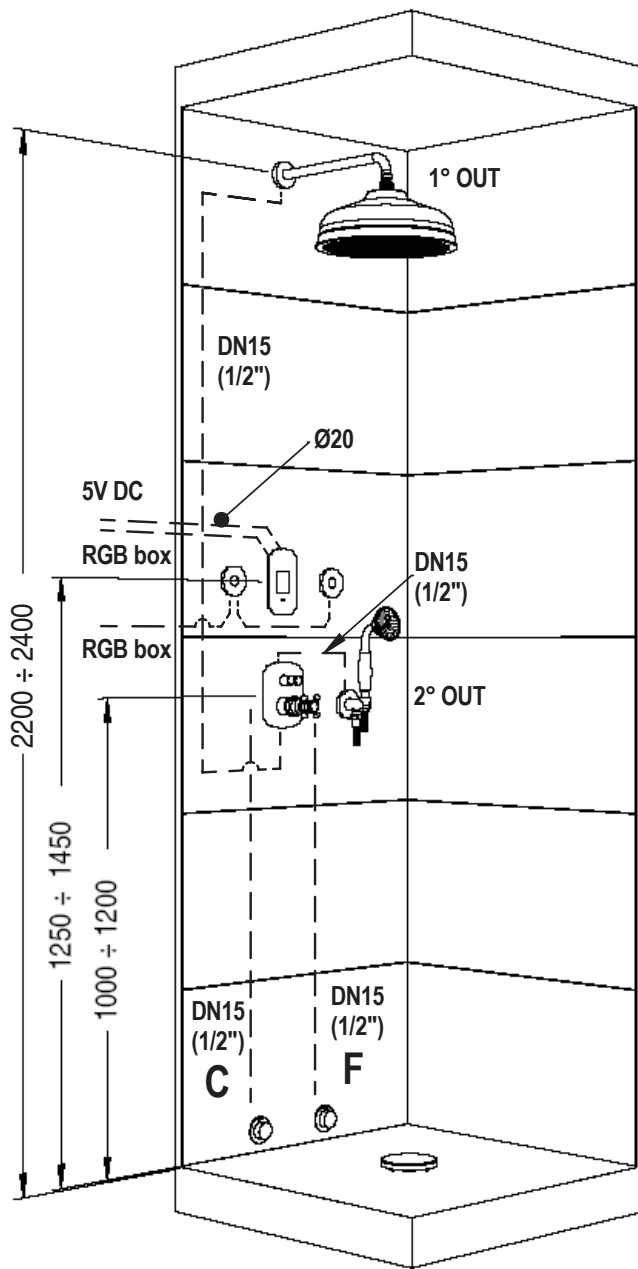
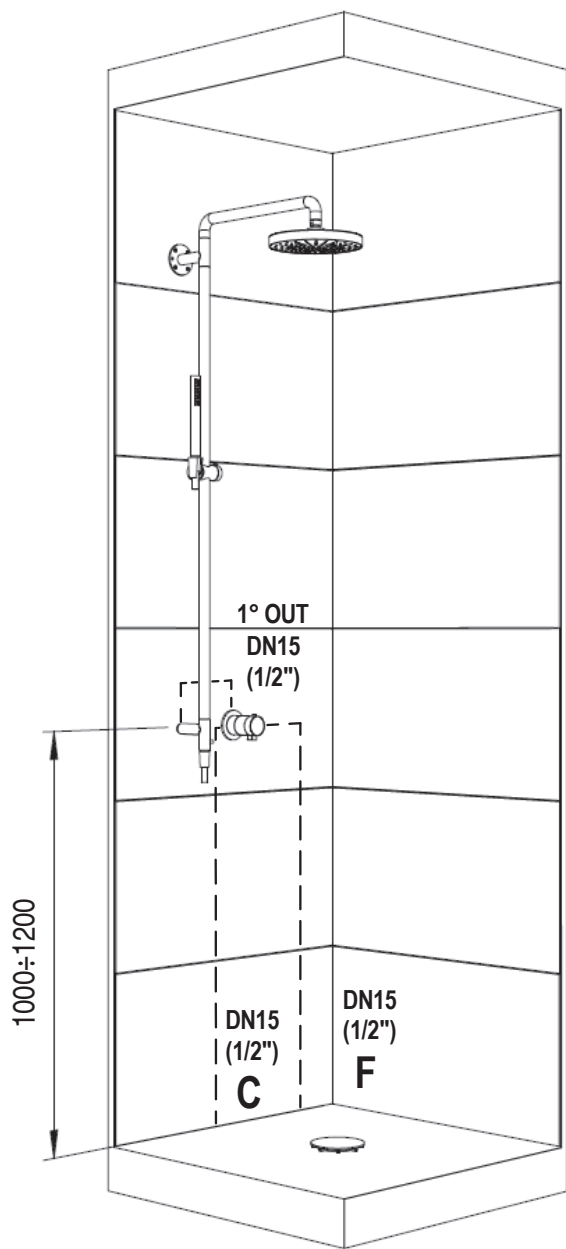

ARTICOLO	QUANTITA'
01-8812/AX/E + 01-124030	1
01-1213/5/1	1
01-8816/E + 775025	1
TOTALE	

ARTICOLO	QUANTITA'
01-035370	1
01-104048	1
01-0800/M/K/E + 01-104002	1
01-0803/1K/A	1
01-104039	2
01-1021/CR1/E + 655184 + 655161 + 655139 (2 pz)	1
01-1320/2/E + 094016	2
01-8816/E + 775025	1
TOTALE	

SUPPORTI DOCCIA



0303/1/A pag. 132

0303/1/A/LL pag. 132

SUPPORTO DOCCIA COMPLETO
FULL SHOWER SUPPORT



0303/1K/A pag. 132

0303/1K/A/LL pag. 132

SUPPORTO DOCCIA COMPLETO
FULL SHOWER SUPPORT



0303/1 pag. 132

0303/1/LL pag. 132

SUPPORTO DOCCIA DUPLEX COMPLETO
FULL SHOWER SUPPORT WITH DUPLEX



0403/1/B pag. 132

SUPPORTO DOCCIA DUPLEX COMPLETO
FULL SHOWER SUPPORT WITH DUPLEX



0403/1/C pag. 132

SUPPORTO DOCCIA COMPLETO
FULL SHOWER SUPPORT



0803/1/A pag. 133

0803/1/A/LL pag. 133

SUPPORTO DOCCIA COMPLETO
FULL SHOWER SUPPORT



0803/1K/A pag. 133

0803/1K/A/LL pag. 133

SUPPORTO DOCCIA COMPLETO
FULL SHOWER SUPPORT



0803/1 pag. 133

0803/1/LL pag. 133

SUPPORTO DOCCIA DUPLEX COMPLETO
FULL SHOWER SUPPORT WITH DUPLEX



0903/1/A pag. 133

SUPPORTO DOCCIA COMPLETO
FULL SHOWER SUPPORT



0903/1 pag. 133

SUPPORTO DOCCIA DUPLEX COMPLETO
FULL SHOWER SUPPORT WITH DUPLEX



1403/1/A pag. 134

SUPPORTO DOCCIA COMPLETO
FULL SHOWER SUPPORT



3303/1/A | BIJOUX pag. 134

SUPPORTO DOCCIA COMPLETO C/SWAROVSKI
FULL SHOWER SUPPORT WITH SWAROVSKI



3303/1 | BIJOUX pag. 134

SUPPORTO DOCCIA DUPLEX COMPLETO C/
SWAROVSKI
FULL SHOWER SUPPORT WITH DUPLEX AND
SWAROVSKI



3503/1 pag. 134

SUPPORTO DOCCIA DUPLEX COMPLETO
FULL SHOWER SUPPORT WITH DUPLEX



4403/1/A pag. 134

SUPPORTO DOCCIA COMPLETO
FULL SHOWER SUPPORT



4403/1 pag. 135

SUPPORTO DOCCIA DUPLEX COMPLETO
FULL SHOWER SUPPORT WITH DUPLEX

SUPPORTI DOCCIA



4503/1/A pag. 135

SUPPORTO DOCCIA COMPLETO
FULL SHOWER SUPPORT



4503/1/AQ pag. 135

SUPPORTO DOCCIA COMPLETO
FULL SHOWER SUPPORT



5503/1/A pag. 135

SUPPORTO DOCCIA COMPLETO
FULL SHOWER SUPPORT



5503/1 pag. 135

SUPPORTO DOCCIA DUPLEX COMPLETO
FULL SHOWER SUPPORT WITH DUPLEX



6003/1 pag. 136

SUPPORTO DOCCIA DUPLEX COMPLETO
FULL SHOWER SUPPORT WITH DUPLEX



6303/1/A pag. 136

SUPPORTO DOCCIA COMPLETO
FULL SHOWER SUPPORT



6503/1/A pag. 136

SUPPORTO DOCCIA COMPLETO
FULL SHOWER SUPPORT



6503/1 pag. 136

SUPPORTO DOCCIA DUPLEX COMPLETO
FULL SHOWER SUPPORT WITH DUPLEX



7503/1/A pag. 136

SUPPORTO DOCCIA COMPLETO
FULL SHOWER SUPPORT



7503/1 pag. 137

SUPPORTO DOCCIA DUPLEX COMPLETO
FULL SHOWER SUPPORT WITH DUPLEX



8003/1/A pag. 137

SUPPORTO DOCCIA COMPLETO
FULL SHOWER SUPPORT



8303/1/A | BIJOUX pag. 137

SUPPORTO DOCCIA COMPLETO C/SWAROVSKI
FULL SHOWER SUPPORT WITH SWAROVSKI



8603/1/A pag. 137

SUPPORTO DOCCIA COMPLETO
FULL SHOWER SUPPORT



8603/1 pag. 137

SUPPORTO DOCCIA DUPLEX COMPLETO
FULL SHOWER SUPPORT WITH DUPLEX



9103/1/A pag. 138

SUPPORTO DOCCIA COMPLETO
FULL SHOWER SUPPORT



9103/1 pag. 138

SUPPORTO DOCCIA DUPLEX COMPLETO
FULL SHOWER SUPPORT WITH DUPLEX



DOCCETTE MULTIFUNZIONE



125089 pag. 138
DOCCIA MULTIFUNZIONE 3 GETTI AREATI CILINDRICA
CYLINDRICAL MULTIFUNCTION 3 AIRY JET HAND SHOWER



125090 pag. 138
DOCCIA MULTIFUNZIONE 3 GETTI AERATI STONDATA
ROUND MULTIFUNCTION 3 AIRY JET HAND SHOWER



125091 pag. 138
DOCCIA MULTIFUNZIONE 3 GETTI CILINDRICA
MULTIFUNCTION 3 AIRY JET HAND SHOWER



125094 pag. 139
DOCCIA MULTIFUNZIONE 2 GETTI QUADRA
SQUARE MULTIFUNCTION 2 AIRY JET HAND SHOWER

SUPPORTI DOCCIA PER BORDO VASCA

NEW



044071 pag. 139
SUPPORTO DOCCIA BV TONDO COMPLETO
COMPLETE ROUND HAND SHOWER SET FOR BATH RIM

NEW



654118 pag. 139
SUPPORTO DOCCIA BV QUADRO COMPLETO
COMPLETE SQUARE HAND SHOWER SET FOR BATH RIM

NEW



084040 pag. 139
084050 pag. 139
SUPPORTO DOCCIA BV PHONE COMPLETO
COMPLETE PHONE HAND SHOWER SET FOR BATH RIM

NEW



104036 pag. 139
104037 pag. 139
SUPPORTO DOCCIA BV CLASSIC COMPLETO
COMPLETE CLASSIC HAND SHOWER SET FOR BATH RIM

SALISCENDI



0530 pag. 140
SALISCENDI COMPLETO C/PRESA D'ACQUA
COMPLETE WALL PIPE WITH WATER CONNECTION



0730 pag. 140
SALISCENDI COMPLETO C/PRESA D'ACQUA
COMPLETE WALL PIPE WITH WATER CONNECTION



0830 pag. 140
SALISCENDI COMPLETO C/PRESA D'ACQUA
COMPLETE WALL PIPE WITH WATER CONNECTION



0830/L pag. 140
0830/LL pag. 140
SALISCENDI COMPLETO C/PRESA D'ACQUA
COMPLETE WALL PIPE WITH WATER CONNECTION



0930 pag. 140
SALISCENDI COMPLETO C/PRESA D'ACQUA
COMPLETE WALL PIPE WITH WATER CONNECTION



1030 pag. 141
SALISCENDI COMPLETO C/PRESA D'ACQUA
COMPLETE WALL PIPE WITH WATER CONNECTION



1230 pag. 141
SALISCENDI COMPLETO C/PRESA ACQUA
COMPLETE WALL PIPE WITH WATER CONNECTION



1430 pag. 141
SALISCENDI COMPLETO C/PRESA D'ACQUA
COMPLETE WALL PIPE WITH WATER CONNECTION

SALISCENDI



1530 pag. 141

1530/LL pag. 141

SALISCENDI COMPLETO C/PRESA D'ACQUA
COMPLETE WALL PIPE WITH WATER CONNECTION



1630 pag. 141

SALISCENDI COMPLETO C/PRESA D'ACQUA
C/SWAROVSKI
COMPLETE WALL PIPE WITH WATER CONNECTION
WITH SWAROVSKI



1730 pag. 142

SALISCENDI COMPLETO C/PRESA D'ACQUA
COMPLETE WALL PIPE WITH WATER CONNECTION



1830 pag. 142

SALISCENDI COMPLETO C/PRESA D'ACQUA
C/SWAROVSKI
COMPLETE WALL PIPE WITH WATER CONNECTION
WITH SWAROVSKI



3330 pag. 142

SALISCENDI COMPLETO C/PRESA D'ACQUA C/
SWAROVSKI
COMPLETE WALL PIPE WITH WATER CONNECTION
AND SWAROVSKI



3563 pag. 142

SALISCENDI COMPLETO C/PRESA D'ACQUA
COMPLETE WALL PIPE WITH WATER CONNECTION



4030 pag. 142

4030/B pag. 142

SALISCENDI COMPLETO C/PRESA D'ACQUA
COMPLETE WALL PIPE WITH WATER CONNECTION



4530 pag. 143

SALISCENDI COMPLETO C/PRESA D'ACQUA
COMPLETE WALL PIPE WITH WATER CONNECTION



5530 pag. 143

SALISCENDI COMPLETO C/PRESA D'ACQUA
COMPLETE WALL PIPE WITH WATER CONNECTION



6330 pag. 143

SALISCENDI COMPLETO C/PRESA D'ACQUA
COMPLETE WALL PIPE WITH WATER CONNECTION



6530 pag. 143

SALISCENDI COMPLETO C/PRESA D'ACQUA
COMPLETE WALL PIPE WITH WATER CONNECTION



7330 pag. 143

SALISCENDI COMPLETO C/PRESA D'ACQUA
COMPLETE WALL PIPE WITH WATER CONNECTION



7530 pag. 144

SALISCENDI COMPLETO C/PRESA D'ACQUA
COMPLETE WALL PIPE WITH WATER CONNECTION



7730 pag. 144

SALISCENDI COMPLETO C/PRESA D'ACQUA
COMPLETE WALL PIPE WITH WATER CONNECTION



7930 pag. 144

SALISCENDI COMPLETO C/PRESA D'ACQUA
COMPLETE WALL PIPE WITH WATER CONNECTION



8030 pag. 144

SALISCENDI COMPLETO C/PRESA D'ACQUA
COMPLETE WALL PIPE WITH WATER CONNECTION



SALISCENDI



8330 pag. 144

SALISCENDI COMPLETO C/PRESA D'ACQUA C/
SWAROVSKI
COMPLETE WALL PIPE WITH WATER CONNECTION
AND SWAROVSKI



8630 pag. 145

SALISCENDI COMPLETO C/PRESA D'ACQUA
COMPLETE WALL PIPE WITH WATER CONNECTION



9130 pag. 145

SALISCENDI COMPLETO C/PRESA D'ACQUA
COMPLETE WALL PIPE WITH WATER CONNECTION



0530/1 pag. 145

ASTA SALISCENDI
WALL PIPE



0830/1 pag. 145

ASTA SALISCENDI
WALL PIPE



0830/1/L pag. 145

0830/1/LL pag. 145

ASTA SALISCENDI
WALL PIPE



0930/1 pag. 146

ASTA SALISCENDI
WALL PIPE



1030/1 pag. 146

ASTA SALISCENDI
WALL PIPE



125074 pag. 146

ASTA SALISCENDI
WALL PIPE



1430/1 pag. 146

ASTA SALISCENDI
WALL PIPE



1630/1 pag. 146

ASTA SALISCENDI C/SWAROVSKI
WALL PIPE WITH SWAROVSKI



1730/1 pag. 147

ASTA SALISCENDI
WALL PIPE



1830/1 pag. 147

ASTA SALISCENDI C/SWAROVSKI
WALL PIPE WITH SWAROVSKI



3330/1 pag. 147

ASTA SALISCENDI C/SWAROVSKI
WALL PIPE WITH SWAROVSKI



4030/1 pag. 147

4030/1/B pag. 147

ASTA SALISCENDI
WALL PIPE



4530/1 pag. 147

ASTA SALISCENDI
WALL PIPE



SALISCENDI



6330/1 pag. 148
 ASTA SALISCENDI
 WALL PIPE



6530/1 pag. 148
 ASTA SALISCENDI
 WALL PIPE



7330/1 pag. 148
 ASTA SALISCENDI
 WALL PIPE



7730/1 pag. 148
 ASTA SALISCENDI
 WALL PIPE



8030/1 pag. 148
 ASTA SALISCENDI
 WALL PIPE



8030/1/A pag. 149
 ASTA SALISCENDI
 WALL PIPE



8330/1 pag. 149
 ASTA SALISCENDI C/SWAROVSKI
 WALL PIPE WITH SWAROVSKI

STELI CON PRESE D'ACQUA

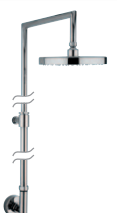

0413/4/SP pag. 149
 STELO DOCCIA
 ROD SHOWER



0513/4 pag. 149
 STELO DOCCIA
 ROD SHOWER



3313/4 pag. 149
 STELO DOCCIA C/SWAROVSKI
 ROD SHOWER WITH SWAROVSKI



6513/4 pag. 150
 STELO DOCCIA
 ROD SHOWER



8013/4 pag. 150
 STELO DOCCIA
 ROD SHOWER



8313/4 pag. 150
 STELO DOCCIA C/SWAROVSKI
 ROD SHOWER WITH SWAROVSKI



0313/5/1 pag. 150
 CURVA PRESA ACQUA C/STELO COMPLETO
 CURVE WATER CONNECTOR WITH COMPLETE ROD

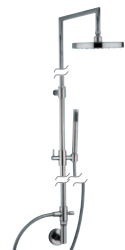

0413/5/1/SP pag. 150
 CURVA PRESA ACQUA C/STELO COMPLETO
 CURVE WATER CONNECTOR WITH COMPLETE ROD



STELI CON PRESE D'ACQUA



0513/5/1 pag. 151
CURVA PRESA ACQUA C/STELO COMPLETO
CURVE WATER CONNECTOR WITH COMPLETE ROD



0713/5/1 pag. 151
CURVA PRESA ACQUA C/STELO COMPLETO
CURVE WATER CONNECTOR WITH COMPLETE ROD



0813/5/1 pag. 151
CURVA PRESA ACQUA C/STELO COMPLETO
CURVE WATER CONNECTOR WITH COMPLETE ROD



0813/5/1/L pag. 151
0813/5/1/LL pag. 151
CURVA PRESA ACQUA C/STELO COMPLETO
CURVE WATER CONNECTOR WITH COMPLETE ROD

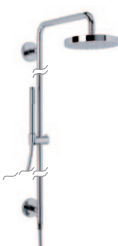

1213/5/1 pag. 151
CURVA PRESA ACQUA C/STELO COMPLETO
CURVE WATER CONNECTOR WITH COMPLETE ROD



3313/5/1 pag. 152
CURVA PRESA ACQUA C/STELO COMPLETO
C/SWAROVSKI
CURVE WATER CONNECTOR WITH COMPLETE ROD
AND SWAROVSKI



4013/5/1 pag. 152
4013/5/1/B pag. 152
CURVA PRESA ACQUA C/STELO COMPLETO
CURVE WATER CONNECTOR WITH COMPLETE ROD



6313/5/1 pag. 152
CURVA PRESA ACQUA C/STELO COMPLETO
CURVE WATER CONNECTOR WITH COMPLETE ROD



6513/5/1 pag. 152
CURVA PRESA ACQUA C/STELO COMPLETO
CURVE WATER CONNECTOR WITH COMPLETE ROD



7513/5/1 pag. 152
CURVA PRESA ACQUA C/STELO COMPLETO
CURVE WATER CONNECTOR WITH COMPLETE ROD



9113/5/1/SP pag. 153
CURVA PRESA ACQUA C/STELO COMPLETO
CURVE WATER CONNECTOR WITH COMPLETE ROD

ACCESSORI PER SALISCENDI E STELI



1015/S pag. 153
CESTINO PORTA SAPONE
SOAP BASKET



0514 pag. 153
CESTINO PORTA SAPONE
SOAP BASKET

NEBULIZZATORI | BODY JET



654112 pag. 153
NEBULIZZATORE INCASSO
BUILT-IN NEBULIZER



884067 pag. 153
NEBULIZZATORE INCASSO
BUILT-IN NEBULIZER

NEBULIZZATORI | BODY JET



104038 pag. 154
NEBULIZZATORE INCASSO
BUILT-IN NEBULIZER



095001 pag. 154
BODY-JET ORIENTABILE QUADRO ESTERNO
ADJUSTABLE SQUARE EXTERNAL BODY-JET



055116 pag. 154
BODY-JET ORIENTABILE
ADJUSTABLE BODY-JET



805001 pag. 154
BODY-JET ORIENTABILE ESTERNO
ADJUSTABLE EXTERNAL BODY-JET



095039/E + 095040 pag. 154
BODYJET INCASSO ORIENTABILE QUADRO
SQUARE BUILT-IN ORIENTABLE BODY-JET



parti esterne / external parts: 095039/E
parte incasso / built-in part: 095040



055251/E + 095040 pag. 155
BODYJET INCASSO ORIENTABILE TONDO
ROUND BUILT-IN ORIENTABLE BODY-JET



parti esterne / external parts: 055251/E
parte incasso / built-in part: 095040

SCARICHI DOCCIA



7716/E + 775025 pag. 155
PILETTA PIATTO DOCCIA QUADRA
WASTE SQUARE FLAT SHOWER



parti esterne / external parts: 7716/E
parte incasso / built-in part: 775025



8816/E + 775025 pag. 155
PILETTA PIATTO DOCCIA TONDA
WASTE ROUND FLAT SHOWER



parti esterne / external parts: 8816/E
parte incasso / built-in part: 775025



8016/E + 775025 pag. 155
PILETTA PIATTO DOCCIA OVALE
WASTE OVAL FLAT SHOWER



parti esterne / external parts: 8016/E
parte incasso / built-in part: 775025



016 pag. 155
PILETTA A GRIGLIA PER SCARICO PIATTO DOCCIA
GRILL DRAINAGE SHOWER TRAIL

GANCI ESTERNI DUPLEX



014081 pag. 156
GANCIO ESTERNO DUPLEX
EXTERNAL MOVABLE HOOK



035102 pag. 156
GANCIO ESTERNO DUPLEX
EXTERNAL MOVABLE HOOK



144023 pag. 156
GANCIO ESTERNO DUPLEX
EXTERNAL MOVABLE HOOK



445005 pag. 156
GANCIO ESTERNO DUPLEX
EXTERNAL MOVABLE HOOK



655005 pag. 156
GANCIO ESTERNO DUPLEX QUADRO
EXTERNAL SQUARE MOVABLE HOOK



804019 pag. 157
GANCIO ESTERNO DUPLEX OVALE
EXTERNAL OVAL MOVABLE HOOK

ACCESSORI PULIZIA



134011 pag. 157

SET COMPLETO DI ACCESSORI PER LA PULIZIA DOCCE
COMPLETE SET FOR SHOWER CLEANING



134012 pag. 157

FLACONE DETERGENTE
CLEANING BOTTLE



0303/1/A

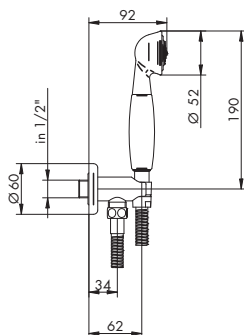

SUPPORTO DOCCIA COMPLETO

- > flessibile in ottone 150 cm
- > presa acqua con supporto fisso
- > doccetta monogetto in metallo senza anticalcare manico in porcellana Ø52
- > attacchi da 1/2"

CROMATO

01-0303/1/A porcellana

01-0303/1/A/LL legno noce €

ALTRE FINITURE

XX-0303/1/A porcellana x M*

XX-0303/1/A/LL legno noce € x M*

0303/1K/A

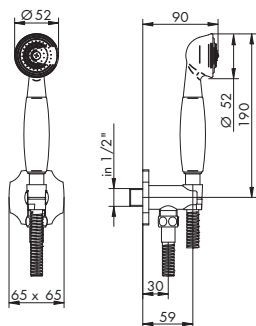

SUPPORTO DOCCIA COMPLETO

- > flessibile in ottone 150 cm
- > presa acqua con supporto fisso
- > doccetta monogetto in metallo senza anticalcare manico in porcellana Ø52
- > attacchi da 1/2"
- > piastra classic

CROMATO

01-0303/1K/A porcellana

01-0303/1K/A/LL legno noce €

ALTRE FINITURE

XX-0303/1K/A porcellana x M*

XX-0303/1K/A/LL legno noce € x M*

0303/1

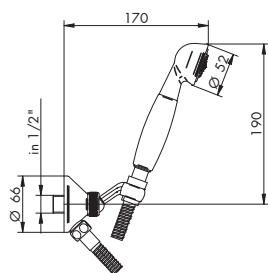

SUPPORTO DOCCIA COMPLETO

- > flessibile in ottone 150 cm
- > presa acqua con supporto snodato
- > doccetta monogetto in metallo senza anticalcare manico in porcellana Ø52
- > attacchi da 1/2"

CROMATO

01-0303/1 porcellana

01-0303/1/LL legno noce €

ALTRE FINITURE

XX-0303/1 porcellana x M*

XX-0303/1/LL legno noce € x M*

0403/1/B

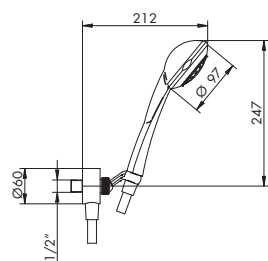

SUPPORTO DOCCIA COMPLETO

- > flessibile in PVC 150 cm
- > presa acqua con supporto snodato
- > attacchi da 1/2"
- > doccetta multigetto in ABS c/anticalcare Ø 97
- > per finiture diverse da quelle di serie chiedere conferma

CROMATO

01-0403/1/B

ALTRE FINITURE

XX-0403/1/B x M*

0403/1/C

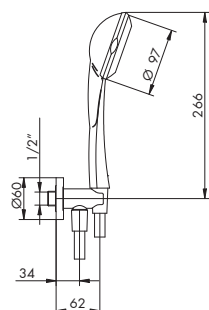

SUPPORTO DOCCIA COMPLETO

- > flessibile in PVC 150 cm
- > presa acqua con supporto snodato
- > attacchi da 1/2"
- > doccetta multigetto in ABS c/anticalcare Ø 97
- > per finiture diverse da quelle di serie chiedere conferma

CROMATO

01-0403/1/C

ALTRE FINITURE

XX-0403/1/C x M*

0803/1/A

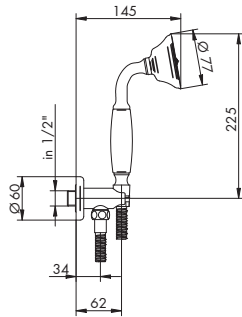

SUPPORTO DOCCIA COMPLETO

- > flessibile in ottone 150 cm
- > presa acqua con supporto fisso
- > doccetta monogetto in metallo senza anticalcare manico in porcellana Ø77
- > attacchi da 1/2"

CROMATO

01-0803/1/A porcellana

01-0803/1/A/LL legno noce €

ALTRE FINITURE

XX-0803/1/A porcellana x M*

XX-0803/1/A/LL legno noce € x M*

0803/1K/A

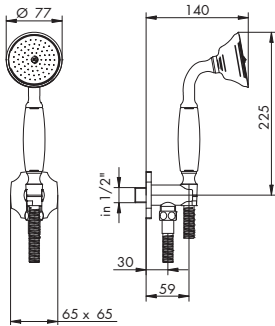

SUPPORTO DOCCIA COMPLETO

- > flessibile in ottone 150 cm
- > presa acqua con supporto fisso
- > doccetta monogetto in metallo senza anticalcare manico in porcellana Ø77
- > attacchi da 1/2"
- > piastra classic

CROMATO

01-0803/1K/A porcellana

01-0803/1K/A/LL legno noce €

ALTRE FINITURE

XX-0803/1K/A porcellana x M*

XX-0803/1K/A/LL legno noce € x M*

0803/1

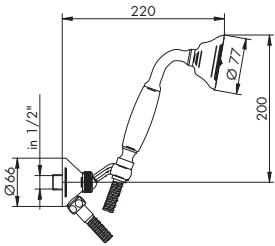

SUPPORTO DOCCIA COMPLETO

- > flessibile in ottone 150 cm
- > presa acqua con supporto snodato
- > doccetta monogetto in metallo senza anticalcare manico in porcellana Ø77
- > attacchi da 1/2"

CROMATO

01-0803/1 porcellana

01-0803/1/LL legno noce €

ALTRE FINITURE

XX-0803/1 porcellana x M*

XX-0803/1/LL legno noce € x M*

0903/1/A

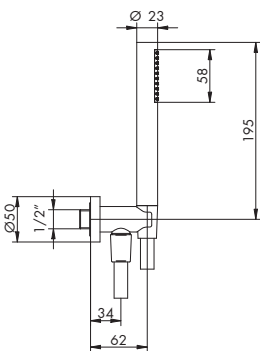

SUPPORTO DOCCIA COMPLETO

- > flessibile in PVC 150 cm
- > presa acqua con supporto fisso
- > attacchi da 1/2"
- > rosone quadro
- > doccetta monogetto cilindrica in ABS c/anticalcare, per finiture diverse da cromo doccetta in metallo

CROMATO

01-0903/1/A

ALTRE FINITURE

XX-0903/1/A x M*

0903/1

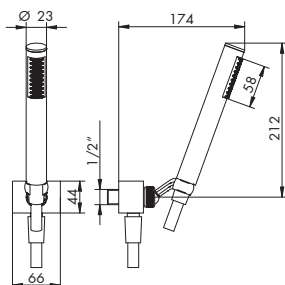

SUPPORTO DOCCIA COMPLETO

- > flessibile in PVC 150 cm
- > presa acqua con supporto orientabile
- > attacchi da 1/2"
- > rosone quadro
- > doccetta monogetto cilindrica in ABS c/anticalcare, per finiture diverse da cromo doccetta in metallo

CROMATO

01-0903/1

ALTRE FINITURE

XX-0903/1 x M*

1403/1/A

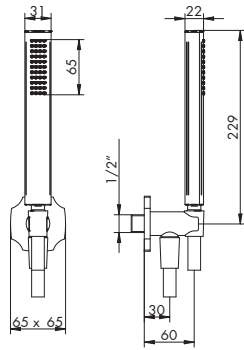

SUPPORTO DOCCIA COMPLETO

- > flessibile in PVC 150 cm
- > presa acqua con supporto fisso
- > doccetta monogetto in metallo c/anticalcare
- > attacchi da 1/2"

CROMATO

01-1403/1/A

ALTRE FINITURE

XX-1403/1/A

x M*

3303/1/A | BIJOUX

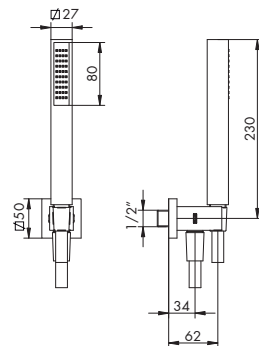

SUPPORTO DOCCIA COMPLETO C/SWAROVSKI

- > flessibile in PVC 150 cm
- > presa acqua con supporto fisso
- > attacchi da 1/2"
- > doccetta monogetto quadra in ABS c/anticalcare, per finiture diverse da cromo doccetta in metallo
- > supporto con SWAROVSKI

CROMATO

01-3303/1/A

ALTRE FINITURE

XX-3303/1/A

x M*

3303/1 | BIJOUX

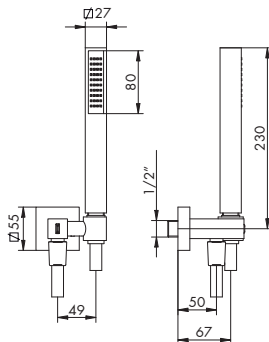

SUPPORTO DOCCIA DUPLEX COMPLETO C/SWAROVSKI

- > flessibile in PVC 150 cm
- > presa acqua con supporto orientabile
- > attacchi da 1/2"
- > doccetta monogetto quadra in ABS c/anticalcare, per finiture diverse da cromo doccetta in metallo
- > supporto orientabile con SWAROVSKI

CROMATO

01-3303/1

ALTRE FINITURE

XX-3303/1

x M*

3503/1

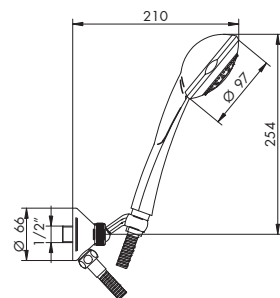

SUPPORTO DOCCIA DUPLEX COMPLETO

- > flessibile in ottone 150 cm
- > presa acqua con supporto snodato
- > attacchi da 1/2"
- > doccetta monogetto in ABS c/anticalcare

CROMATO

01-3503/1

ALTRE FINITURE

XX-3503/1

x M*

4403/1/A

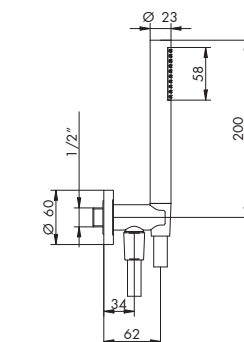

SUPPORTO DOCCIA COMPLETO

- > flessibile in PVC 150 cm
- > presa acqua con supporto fisso
- > attacchi da 1/2"
- > doccetta monogetto cilindrica in abs c/anticalcare
- > per finiture diverse da cromo doccetta in metallo

CROMATO

01-4403/1/A

ALTRE FINITURE

XX-4403/1/A

x M*

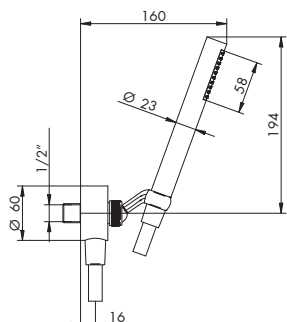

4403/1

**SUPPORTO DOCCIA DUPLEX COMPLETO**

- > flessibile in PVC 150 cm
- > presa acqua con supporto fisso
- > attacchi da 1/2"
- > doccetta monogetto ciliin ABS c/anticalcare, per finiture diverse da cromo doccetta in metallo

CROMATO

01-4403/1

ALTRE FINITURE

XX-4403/1

x M*

4503/1/A

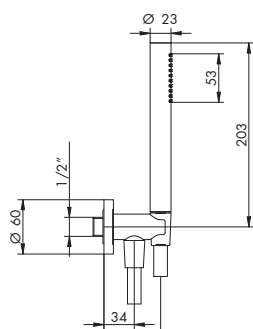
**SUPPORTO DOCCIA COMPLETO**

- > flessibile in PVC 150 cm
- > presa acqua con supporto fisso
- > attacchi da 1/2"
- > doccetta monogetto inox c/anticalcare

INOX AISI 316L

77-4503/1/A

4503/1/AQ

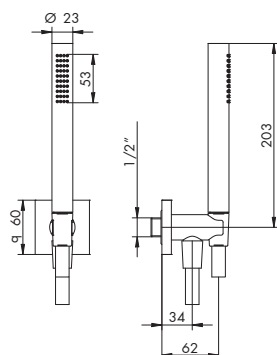
**SUPPORTO DOCCIA COMPLETO**

- > flessibile in PVC 150 cm
- > presa acqua con supporto fisso
- > attacchi da 1/2"
- > doccetta monogetto inox c/anticalcare
- > rosone quadro

INOX AISI 316L

77-4503/1/AQ

5503/1/A

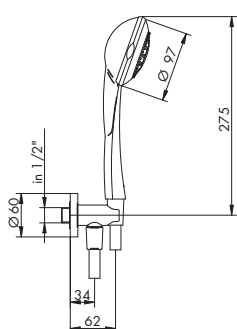
**SUPPORTO DOCCIA COMPLETO**

- > flessibile in ottone 150 cm
- > presa acqua con supporto fisso
- > attacchi da 1/2"
- > doccetta multigetto in ABS c/anticalcare

CROMATO

01-5503/1/A

ALTRE FINITURE

XX-5503/1/A

x M*

5503/1

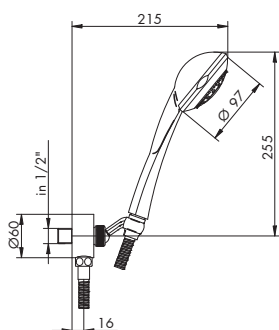
**SUPPORTO DOCCIA DUPLEX COMPLETO**

- > flessibile in ottone 150 cm
- > presa acqua con supporto snodato
- > attacchi da 1/2"
- > doccetta multigetto in ABS c/anticalcare, per finiture diverse da quelle di serie chiedere conferma

CROMATO

01-5503/1

ALTRE FINITURE

XX-5503/1

x M*

6003/1

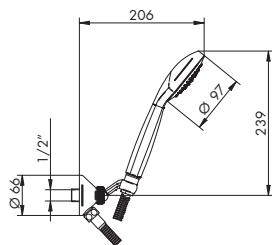

SUPPORTO DOCCIA COMPLETO

- > flessibile in ottone 150 cm
- > presa acqua con supporto snodato
- > attacchi da 1/2"
- > doccetta monogetto in ABS c/anticalcare

CROMATO

01-6003/1

ALTRE FINITURE

XX-6003/1

x M*

6303/1/A

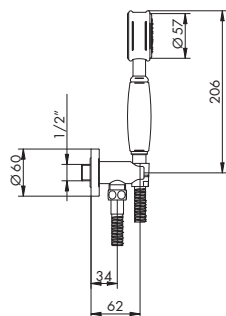

SUPPORTO DOCCIA COMPLETO

- > flessibile in ottone 150 cm
- > presa acqua con supporto fisso
- > doccetta monogetto in metallo (vedi pag. 121)
- > attacchi da 1/2"

CROMATO

01-6303/1/A-01 ins. in finitura €
 01-6303/1/A-66 ins. bianco op. €
 01-6303/1/A-67 ins. nero op. €

ALTRE FINITURE

XX-6303/1/A-XX ins. in finitura €
 XX-6303/1/A-66 ins. bianco op. €
 XX-6303/1/A-67 ins. nero op. €

6503/1/A

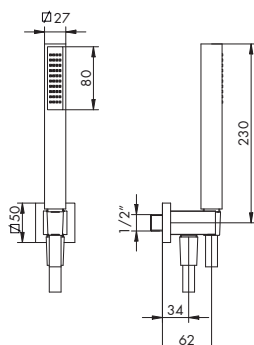

SUPPORTO DOCCIA COMPLETO

- > flessibile in PVC 150 cm
- > presa acqua con supporto fisso
- > attacchi da 1/2"
- > doccetta monogetto quadra in ABS c/anticalcare, per finiture diverse da cromo doccetta in metallo

CROMATO

01-6503/1/A

ALTRE FINITURE

XX-6503/1/A

x M*

6503/1

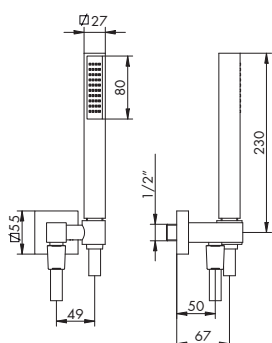

SUPPORTO DOCCIA DUPLEX COMPLETO

- > flessibile in PVC 150 cm
- > presa acqua con supporto orientabile
- > attacchi da 1/2"
- > doccetta monogetto quadra in ABS c/anticalcare, per finiture diverse da cromo doccetta in metallo

CROMATO

01-6503/1

ALTRE FINITURE

XX-6503/1

x M*

7503/1/A

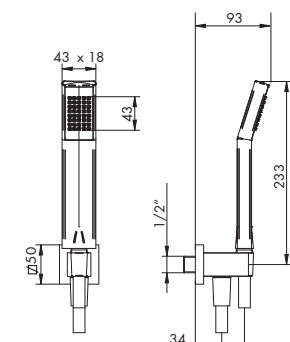

SUPPORTO DOCCIA COMPLETO

- > flessibile in PVC 150 cm
- > presa acqua con supporto fisso
- > attacchi da 1/2"
- > doccetta monogetto rettangolare in ABS c/anticalcare
- > per finiture diverse da cromo doccetta quadra in metallo (ordinare art. 6503/1/A)

CROMATO

01-7503/1/A

7503/1

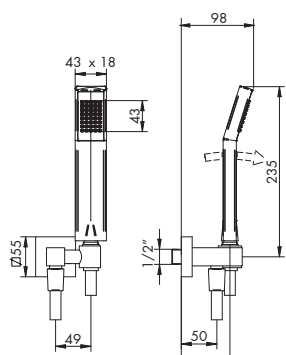
**SUPPORTO DOCCIA DUPLEX COMPLETO**

- > flessibile in PVC 150 cm
- > presa acqua con supporto orientabile
- > attacchi da 1/2"
- > doccetta monogetto rettangolare in ABS c/anticalcare, per finiture diverse da cromo doccetta quadra in metallo (ordinare art. 6503/1)

CROMATO

01-7503/1

8003/1/A

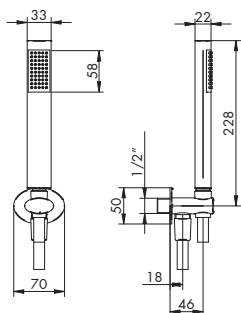
**SUPPORTO DOCCIA COMPLETO**

- > flessibile in PVC 150 cm
- > presa acqua con supporto fisso
- > attacchi da 1/2"
- > doccetta monogetto ovale in ABS c/anticalcare, per finiture diverse da cromo doccetta tonda in metallo

CROMATO

01-8003/1/A

ALTRE FINITURE

XX-8003/1/A

x M*

8303/1/A | BIJOUX

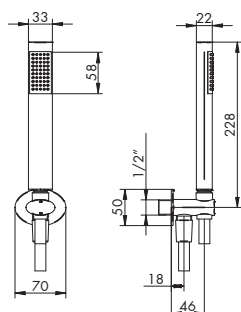
**SUPPORTO DOCCIA COMPLETO C/SWAROVSKI**

- > flessibile in PVC 150 cm
- > presa acqua con supporto fisso
- > attacchi da 1/2"
- > doccetta monogetto ovale in ABS c/anticalcare, per finiture diverse da cromo doccetta tonda in metallo
- > supporto con SWAROVSKI

CROMATO

01-8303/1/A

ALTRE FINITURE

XX-8303/1/A

x M*

8603/1/A

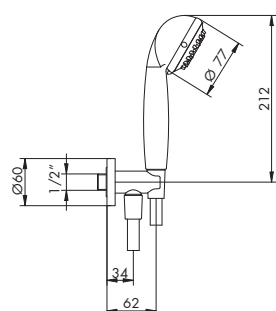
**SUPPORTO DOCCIA COMPLETO**

- > flessibile in PVC 150 cm
- > presa acqua con supporto fisso
- > attacchi da 1/2"
- > doccetta multigetto in ABS c/anticalcare

CROMATO

01-8603/1/A

8603/1

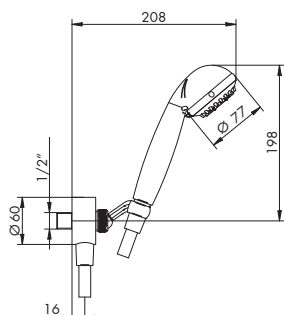
**SUPPORTO DOCCIA DUPLEX COMPLETO**

- > flessibile in PVC 150 cm
- > presa acqua con supporto snodato
- > attacchi da 1/2"
- > doccetta multigetto in ABS c/anticalcare

CROMATO

01-8603/1

9103/1/A

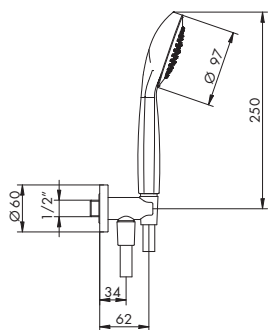

SUPPORTO DOCCIA COMPLETO

- > flessibile in PVC 150 cm
- > presa acqua con supporto fisso
- > attacchi da 1/2"
- > doccetta monogetto in ABS c/anticalcare

CROMATO
01-9103/1/A

ALTRE FINITURE
XX-9103/1/A

x M*

9103/1

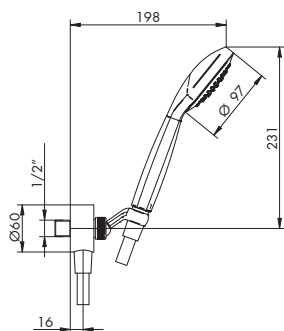

SUPPORTO DOCCIA DUPLEX COMPLETO

- > flessibile in PVC 150 cm
- > presa acqua con supporto orientabile
- > attacchi da 1/2"
- > doccetta monogetto in ABS c/anticalcare

CROMATO
01-9103/1

ALTRE FINITURE
XX-9103/1

x M*

125089

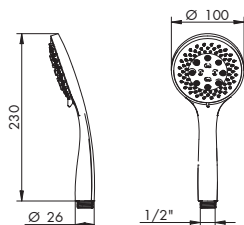

DOCCETTA MULTIFUNZIONE 3 GETTI AREATI CILINDRICA

- > corpo esterno in ABS
- > ugelli siliconici anticalcare
- > Ø100
- > attacco da 1/2"

CROMATO
01-125089

125090

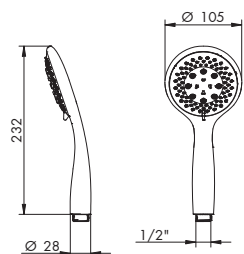

DOCCETTA MULTIFUNZIONE 3 GETTI AREATI STONDATA

- > corpo esterno in ABS
- > ugelli siliconici anticalcare
- > Ø105
- > attacco da 1/2"

CROMATO
01-125090

125091

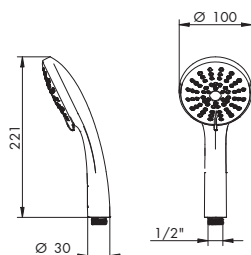

DOCCETTA MULTIFUNZIONE 3 GETTI CILINDRICA

- > corpo esterno in ABS
- > ugelli siliconici anticalcare
- > Ø100
- > attacco da 1/2"

CROMATO
01-125091

125094

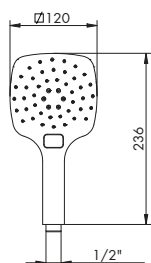

DOCCHETTA MULTIFUNZIONE 2 GETTI QUADRA

- > corpo esterno in ABS
- > ugelli siliconici anticalcare
- > 120 x 120
- > attacco da 1/2"

CROMATO
01-125094

044071

NEW

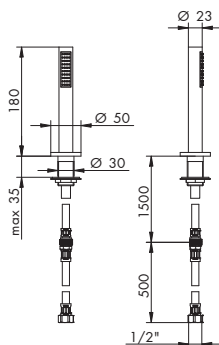

SUPPORTO DOCCIA BV TONDO COMPLETO

- > flessibile in PVC 150 cm
- > attacco da 1/2"
- > doccetta monogetto cilindrica in ABS c/anticalcare, per finiture diverse da cromo doccetta in metallo

CROMATO
01-044071

ALTRE FINITURE
XX-044071

x M*

654118

NEW

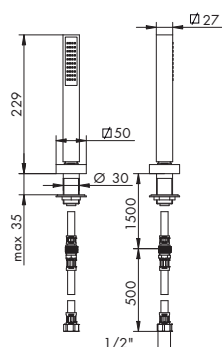

SUPPORTO DOCCIA BV QUADRO COMPLETO

- > flessibile in PVC 150 cm
- > attacco da 1/2"
- > doccetta monogetto cilindrica in ABS c/anticalcare, per finiture diverse da cromo doccetta in metallo

CROMATO
01-654118

ALTRE FINITURE
XX-654118

x M*

084040 | 084050

NEW

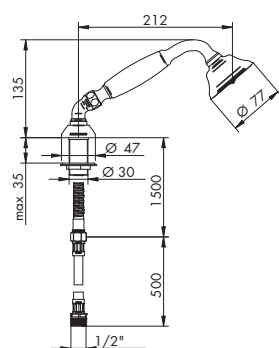

SUPPORTO DOCCIA BV PHONE COMPLETO

- > flessibile in ottone 150 cm
- > doccetta monogetto in metallo senza anticalcare:
- manico in porcellana Ø77 (art. 084040)
- manico in legno Ø77 (art. 084050)
- > attacco da 1/2"

CROMATO
01-084040 porcellana
01-084050 legno noce €

ALTRE FINITURE
XX-084040 porcellana
XX-084050 legno noce €

x M*
x M*

104036 | 104037

NEW

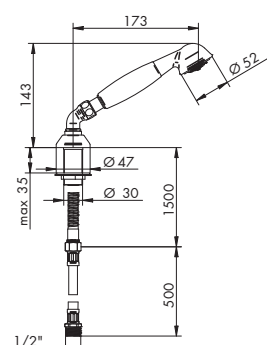

SUPPORTO DOCCIA BV CLASSIC COMPLETO

- > flessibile in ottone 150 cm
- > doccetta monogetto in metallo senza anticalcare:
- manico in porcellana Ø52 (art. 104036)
- manico in legno Ø52 (art. 104037)
- > attacco da 1/2"

CROMATO
01-104036 porcellana
01-104037 legno noce €

ALTRE FINITURE
XX-104036 porcellana
XX-104037 legno noce €

x M*
x M*

0530

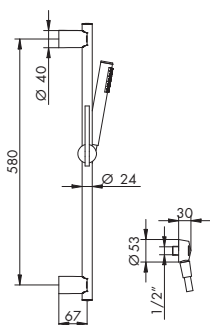
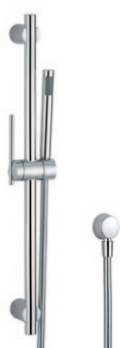

SALISCENDI COMPLETO C/PRESA D'ACQUA

- > flessibile in PVC 150 cm
- > supporto doccetta scorrevole orientabile
- > presa acqua da 1/2"
- > doccetta monogetto cilindrica in ABS c/anticalcare, per finiture diverse da cromo doccetta in metallo

CROMATO	ALTRE FINITURE
01-0530	XX-0530 x M*

0730

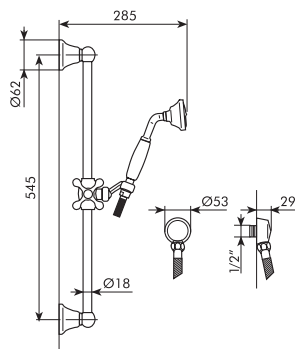

SALISCENDI COMPLETO C/PRESA D'ACQUA

- > flessibile in metallo 150 cm
- > supporto doccetta scorrevole snodato
- > presa acqua da 1/2"
- > doccetta monogetto in metallo senza anticalcare manico in porcellana Ø77

CROMATO	ALTRE FINITURE
01-0730	XX-0730 x M*

0830

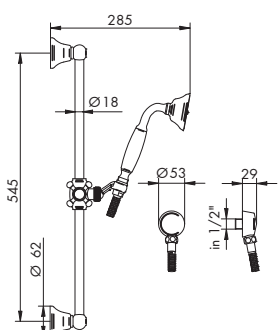

SALISCENDI COMPLETO C/PRESA D'ACQUA

- > flessibile in metallo 150 cm
- > Supporto doccetta scorrevole snodato
- > presa acqua da 1/2"
- > doccetta monogetto in metallo senza anticalcare manico in porcellana Ø77

CROMATO	ALTRE FINITURE
01-0830	XX-0830 x M*

0830/L

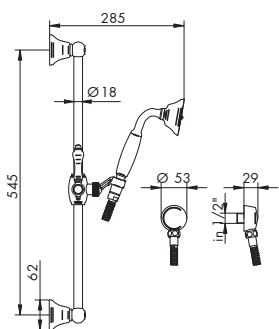

SALISCENDI COMPLETO C/PRESA D'ACQUA

- > flessibile in ottone 150 cm
- > Supporto doccetta scorrevole snodato
- > presa acqua da 1/2"
- > doccetta monogetto in metallo senza anticalcare manico in porcellana o legno Ø77
- > leva con inserto in porcellana o legno

CROMATO	ALTRE FINITURE
01-0830/L porcellana	XX-0830/L porcellana x M*
01-0830/LL legno noce €	XX-0830/LL legno noce € x M*

0930

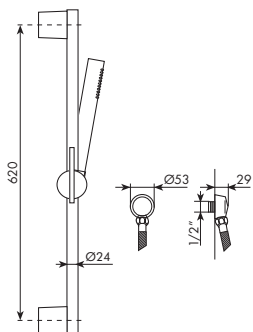

SALISCENDI COMPLETO C/PRESA D'ACQUA

- > flessibile in PVC 150 cm
- > supporto doccetta scorrevole orientabile
- > presa acqua da 1/2"
- > doccetta monogetto cilindrica in ABS c/anticalcare, per finiture diverse da cromo doccetta in metallo

CROMATO	ALTRE FINITURE
01-0930	XX-0930 x M*

1030

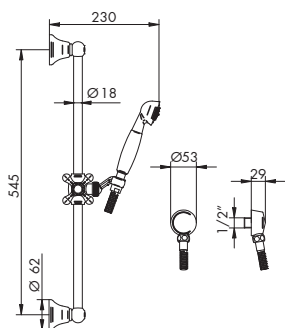
**SALISCENDI COMPLETO C/PRESA D'ACQUA**

- > flessibile in ottone 150 cm
- > supporto doccetta scorrevole snodato
- > presa acqua da 1/2"
- > doccetta monogetto in metallo senza anticalcare manico in porcellana Ø52

CROMATO

01-1030

ALTRE FINITURE

XX-1030

x M*

1230

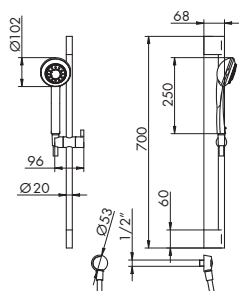
**SALISCENDI COMPLETO C/PRESA D'ACQUA**

- > saliscendi con attacchi in ABS
- > scorrevole in ABS
- > doccetta monogetto in ABS
- > flessibile in PVC 150 cm

CROMATO

01-1230

1430

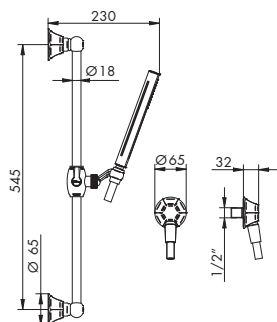
**SALISCENDI COMPLETO C/PRESA D'ACQUA**

- > flessibile in PVC 150 cm
- > supporto doccetta scorrevole snodato
- > presa acqua da 1/2"
- > doccetta monogetto in metallo c/anticalcare

CROMATO

01-1430

ALTRE FINITURE

XX-1430

x M*

1530

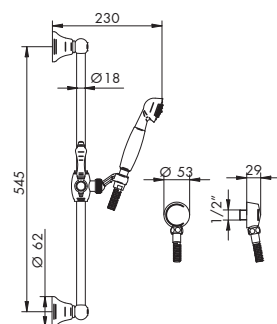
**SALISCENDI COMPLETO C/PRESA D'ACQUA**

- > flessibile in ottone 150 cm
- > supporto doccetta scorrevole snodato
- > presa acqua da 1/2"
- > doccetta monogetto in metallo senza anticalcare manico in porcellana o legno Ø52
- > leva con inserto in porcellana o legno

CROMATO

01-1530

porcellana

01-1530/LL

legno noce

€

ALTRE FINITURE

XX-1530

porcellana

XX-1530/LL

legno noce

€

x M*

x M*

1630

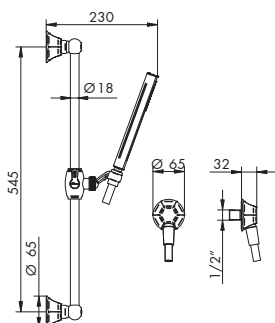
**SALISCENDI COMPLETO C/PRESA D'ACQUA C/SWAROVSKI**

- > flessibile in PVC 150 cm
- > supporto doccetta scorrevole snodato
- > presa acqua da 1/2"
- > doccetta monogetto in metallo c/anticalcare
- > leva con SWAROVSKI

CROMATO

01-1630

ALTRE FINITURE

XX-1630

x M*

1730

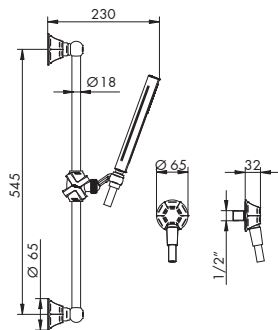
**SALISCENDI COMPLETO C/PRESA D'ACQUA**

- > flessibile in PVC 150 cm
- > supporto doccetta scorrevole snodato
- > presa acqua da 1/2"
- > doccetta monogetto in metallo c/anticalcare
- > maniglia a croce

CROMATO

01-1730

ALTRE FINITURE**XX-1730****x M***

1830

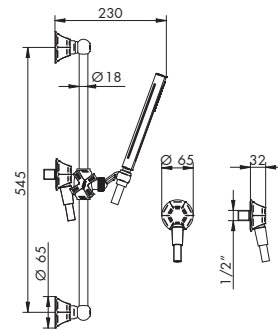
**SALISCENDI COMPLETO C/PRESA D'ACQUA C/SWAROVSKI**

- > flessibile in PVC 150 cm
- > supporto doccetta scorrevole snodato
- > presa acqua da 1/2"
- > doccetta monogetto in metallo c/anticalcare
- > maniglia a croce con SWAROVSKI

CROMATO

01-1830

ALTRE FINITURE**XX-1830****x M***

3330 | BIJOUX

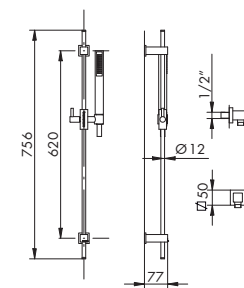
**SALISCENDI COMPLETO C/PRESA D'ACQUA C/SWAROVSKI**

- > flessibile in PVC 150 cm
- > supporto doccetta quadro scorrevole orientabile con SWAROVSKI
- > stelo c/asta tonda supporti quadri
- > presa acqua da 1/2"
- > doccetta monogetto quadra in abs c/anticalcare, per finiture diverse da cromo doccetta in metallo

CROMATO

01-3330

ALTRE FINITURE**XX-3330****x M***

3563

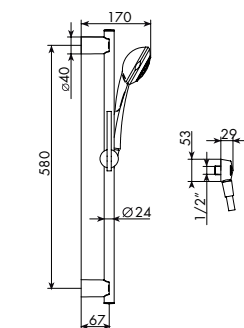
**SALISCENDI COMPLETO C/PRESA D'ACQUA**

- > doccetta in ABS
- > flessibile in PVC 150 cm
- > supporto doccetta snodato
- > presa acqua da 1/2"

CROMATO

01-3563

ALTRE FINITURE**XX-3563****x M***

4030

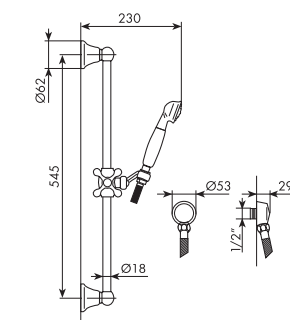
**SALISCENDI COMPLETO C/PRESA D'ACQUA**

- > flessibile in ottone 150 cm
- > supporto doccetta scorrevole snodato
- > presa acqua da 1/2"
- > doccetta monogetto in metallo senza anticalcare manico in porcellana Ø52
- > maniglia a croce porcellana decorata

CROMATO

01-4030 decorata

01-4030/B

bianca

€

ALTRE FINITURE**XX-4030** decorata**XX-4030/B** bianca

€

x M***x M***

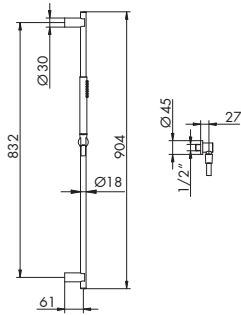

4530

**SALISCENDI INOX COMPLETO C/PRESA D'ACQUA**

- > flessibile in PVC 150 cm
- > supporto doccetta scorrevole orientabile
- > presa acqua da 1/2"
- > doccetta monogetto inox c/anticalcare

INOX AISI 316L**77-4530**

5530

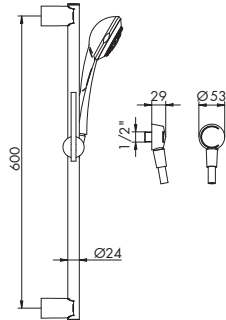
**SALISCENDI COMPLETO C/PRESA D'ACQUA**

- > flessibile in ottone 150 cm
- > supporto doccetta scorrevole orientabile
- > presa acqua da 1/2"
- > doccetta multigetto in ABS c/anticalcare

CROMATO**01-5530****ALTRE FINITURE****XX-5530****x M***

6330

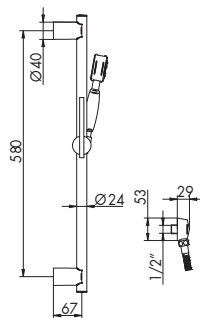
**SALISCENDI COMPLETO C/PRESA D'ACQUA**

- > flessibile in metallo 150 cm
- > supporto doccetta scorrevole orientabile
- > doccetta monogetto in metallo (vedi pag. 121)
- > presa acqua da 1/2"

CROMATO**01-6330-01** leva+ins. in finitura €**01-6330-66** leva+ins. bianco op. €**01-6330-67** leva+ins. nero op. €**ALTRE FINITURE****XX-6330-XX** leva+ins. in finitura €**XX-6330-66** leva+ins. bianco op. €**XX-6330-67** leva+ins. nero op. €

6530

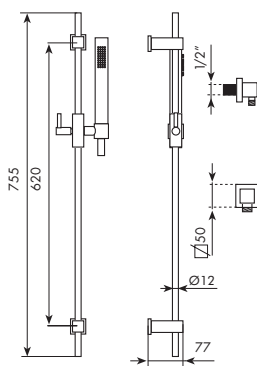
**SALISCENDI COMPLETO C/PRESA D'ACQUA**

- > flessibile in PVC 150 cm
- > supporto doccetta quadro scorrevole orientabile
- > stelo c/asta tonda supporti quadri
- > presa acqua da 1/2"
- > doccetta monogetto quadra in ABS c/anticalcare, per finiture diverse da cromo doccetta in metallo

CROMATO**01-6530****ALTRE FINITURE****XX-6530****x M***

7330

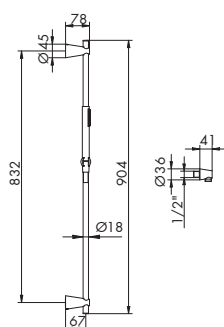
**SALISCENDI COMPLETO C/PRESA D'ACQUA**

- > flessibile in PVC 150 cm
- > supporto doccetta scorrevole orientabile
- > presa acqua da 1/2"
- > doccetta monogetto cilindrica in ABS c/anticalcare, per finiture diverse da cromo doccetta in metallo

CROMATO**01-7330****ALTRE FINITURE****XX-7330****x M***

7530

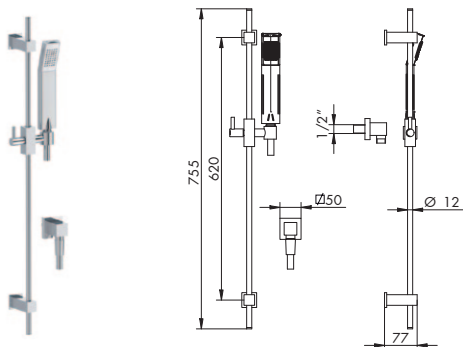

SALISCENDI COMPLETO C/PRESA D'ACQUA

- > flessibile in PVC 150 cm
- > supporto doccetta quadro scorrevole orientabile
- > stelo c/asta tonda supporti quadri
- > presa acqua da 1/2"
- > doccetta monogetto rettangolare in ABS c/anticalcare, per finiture diverse da cromo doccetta quadra in metallo (ordinare art. 6530)

CROMATO

01-7530

7730

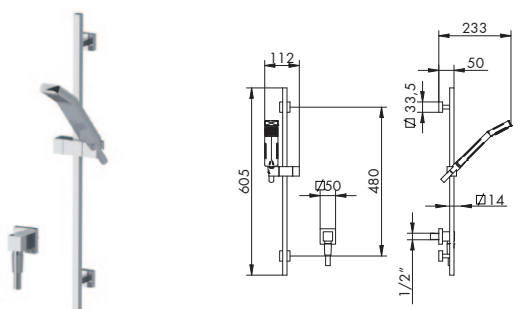

SALISCENDI COMPLETO C/PRESA D'ACQUA

- > flessibile in PVC 150 cm
- > supporto doccetta quadro scorrevole orientabile
- > stelo c/asta quadra
- > presa acqua da 1/2"
- > doccetta monogetto rettangolare in ABS c/anticalcare, per finiture diverse da cromo doccetta quadra in metallo (art. 7930)

CROMATO

01-7730

7930

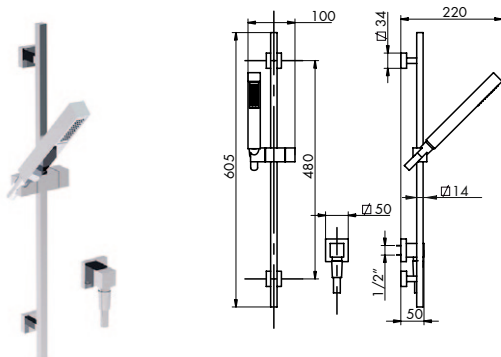

SALISCENDI COMPLETO C/PRESA D'ACQUA

- > flessibile in PVC 150 cm
- > supporto doccetta quadro scorrevole orientabile
- > stelo c/asta quadra
- > presa acqua da 1/2"
- > doccetta monogetto quadra in ABS c/anticalcare, per finiture diverse da cromo doccetta in metallo

CROMATO

01-7930

8030

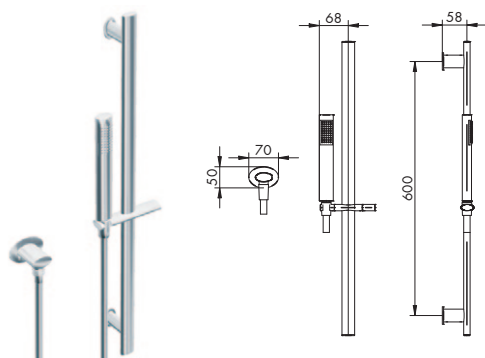

SALISCENDI COMPLETO C/PRESA D'ACQUA

- > flessibile in PVC 150 cm
- > supporto doccetta ovale scorrevole orientabile
- > stelo c/asta ovale
- > presa acqua da 1/2"
- > doccetta monogetto quadra in ABS c/anticalcare, per finiture diverse da cromo doccetta tonda in metallo

CROMATO

01-8030

ALTRE FINITURE

XX-8030

x M*

8330 | BIJOUX

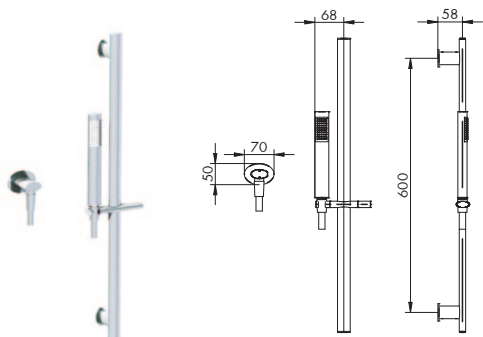

SALISCENDI COMPLETO C/PRESA D'ACQUA C/SWAROVSKI

- > flessibile in PVC 150 cm
- > supporto doccetta ovale scorrevole orientabile
- > stelo c/asta ovale
- > presa acqua da 1/2"
- > doccetta monogetto quadra in ABS c/anticalcare, per finiture diverse da cromo doccetta tonda in metallo
- > maniglia scorrevole e presa acqua con SWAROVSKI

CROMATO

01-8330

ALTRE FINITURE

XX-8330

x M*



8630

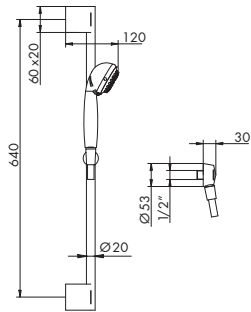

SALISCENDI COMPLETO C/PRESA D'ACQUA

- > flessibile in PVC 150 cm
- > supporto doccetta scorrevole snodato
- > presa acqua da 1/2"
- > doccetta multigetto in ABS c/anticalcare
- > stelo con asta tonda

CROMATO
01-8630

9130

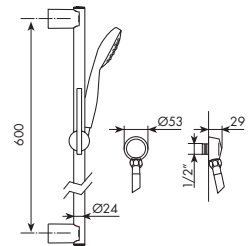

SALISCENDI COMPLETO C/PRESA D'ACQUA

- > flessibile in PVC 150 cm
- > supporto doccetta scorrevole orientabile
- > presa acqua da 1/2"
- > doccetta monogetto in ABS c/anticalcare

CROMATO
01-9130

ALTRE FINITURE
XX-9130

x M*

0530/1

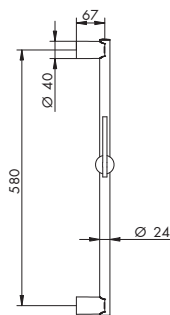

ASTA SALISCENDI

- > supporto doccetta scorrevole orientabile

CROMATO
01-0530/1

ALTRE FINITURE
XX-0530/1

x M*

0830/1

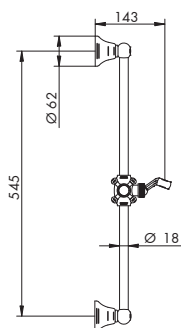

ASTA SALISCENDI

- > supporto doccetta scorrevole snodato

CROMATO
01-0830/1

ALTRE FINITURE
XX-0830/1

x M*

0830/1/L

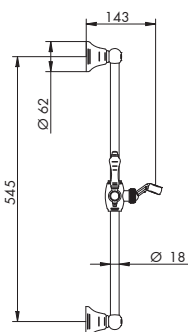

ASTA SALISCENDI

- > supporto doccetta scorrevole snodato
- > leva con inserto in porcellana o legno

CROMATO

01-0830/1/L porcellana
01-0830/1/LL legno noce €

ALTRE FINITURE

XX-0830/1/L porcellana x M*
XX-0830/1/LL legno noce € x M*

0930/1

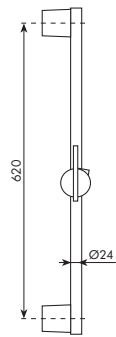

ASTA SALISCENDI

> supporto doccetta scorrevole orientabile

CROMATO
01-0930/1ALTRE FINITURE
XX-0930/1

x M*

1030/1

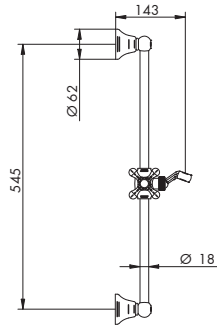

ASTA SALISCENDI

> supporto doccetta scorrevole snodato

CROMATO
01-1030/1ALTRE FINITURE
XX-1030/1

x M*

125074

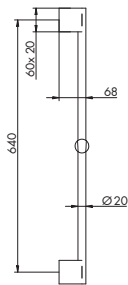

ASTA SALISCENDI

> supporto doccetta scorrevole snodato

CROMATO
01-125074

1430/1

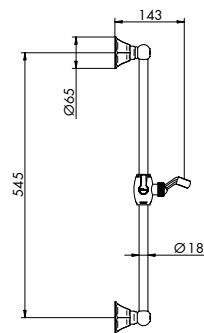

ASTA SALISCENDI

> supporto doccetta scorrevole snodato

CROMATO
01-1430/1ALTRE FINITURE
XX-1430/1

x M*

1630/1

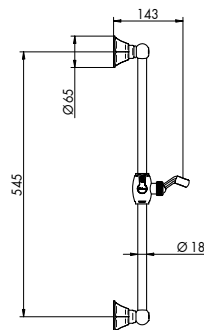

ASTA SALISCENDI

> supporto doccetta scorrevole snodato
> leva con SWAROVSKICROMATO
01-1630/1ALTRE FINITURE
XX-1630/1

x M*



1730/1

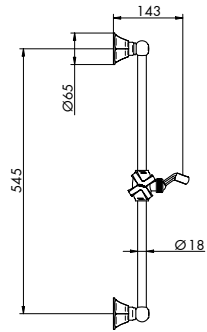

ASTA SALISCENDI

- > supporto doccetta scorrevole snodato
- > maniglia a croce

CROMATO
01-1730/1

ALTRE FINITURE
XX-1730/1 x M*

1830/1

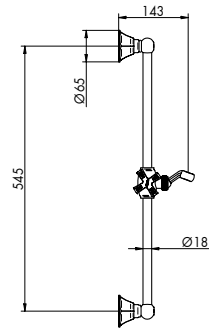

ASTA SALISCENDI

- > supporto doccetta scorrevole snodato
- > maniglia a croce con SWAROVSKI

CROMATO
01-1830/1

ALTRE FINITURE
XX-1830/1 x M*

3330/1 | BIJOUX

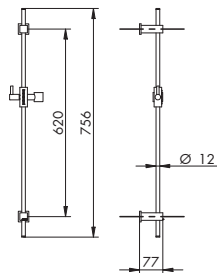

ASTA SALISCENDI C/SWAROVSKI

- > supporto doccetta quadro scorrevole orientabile con SWAROVSKI
- > stelo c/asta tonda supporti quadri

CROMATO
01-3330/1

ALTRE FINITURE
XX-3330/1 x M*

4030/1

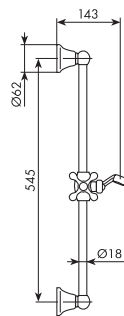

ASTA SALISCENDI

- > supporto doccetta scorrevole snodato
- > maniglia a croce porcellana decorata o bianca

CROMATO	
01-4030/1	decorata
01-4030/1/B	bianca €

ALTRE FINITURE	
XX-4030/1	decorata x M*
XX-4030/1/B	bianca € x M*

4530/1

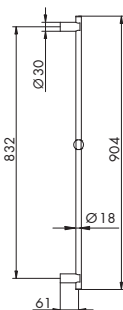

ASTA SALISCENDI

- > supporto doccetta scorrevole orientabile

INOX AISI 316L	
77-4530/1	€

6330/1

ASTA SALISCENDI

> supporto doccetta scorrevole orientabile

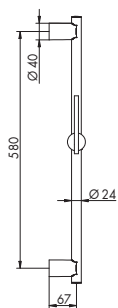

CROMATO

01-6330/1-01	leva in finitura	€
01-6330/1-66	leva bianco op.	€
01-6330/1-67	leva nero op.	€

ALTRE FINITURE

XX-6330/1-XX	leva in finitura	€
XX-6330/1-66	leva bianco op.	€
XX-6330/1-67	leva nero op.	€

6530/1

ASTA SALISCENDI

> supporto doccetta quadro scorrevole orientabile
> stelo c/asta tonda supporti quadri

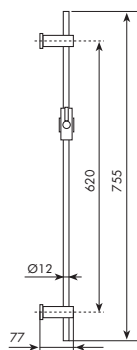

CROMATO

01-6530/1		
-----------	--	--

ALTRE FINITURE

XX-6530/1		x M*
-----------	--	------

7330/1

ASTA SALISCENDI

> supporto doccetta scorrevole orientabile

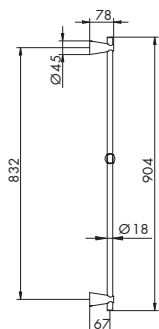

CROMATO

01-7330/1		
-----------	--	--

ALTRE FINITURE

XX-7330/1		x M*
-----------	--	------

7730/1

ASTA SALISCENDI

> supporto doccetta quadro scorrevole orientabile
> stelo c/asta quadro

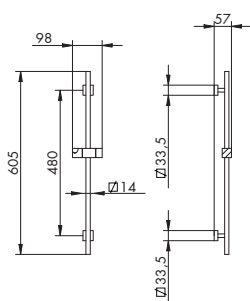

CROMATO

01-7730/1		
-----------	--	--

8030/1

ASTA SALISCENDI

> supporto doccetta ovale scorrevole orientabile
> stelo c/asta ovale

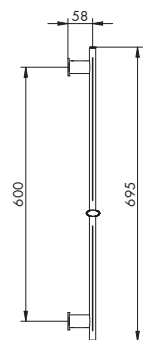

CROMATO

01-8030/1		€
-----------	--	---

ALTRE FINITURE

XX-8030/1		€	x M*
-----------	--	---	------



8030/1/A

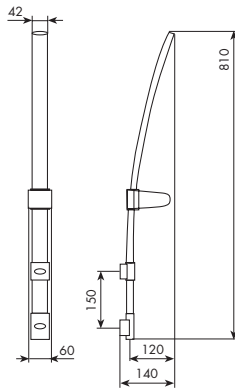

ASTA SALISCENDI

> supporto doccetta scorrevole ABS

CROMATO

01-8030/1/A

8330/1 | BIJOUX

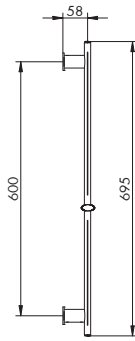

ASTA SALISCENDI C/SWAROVSKI

> supporto doccetta scorrevole orientabile
> maniglia scorrevole con SWAROVSKI

CROMATO

01-8330/1

ALTRE FINITURE

XX-8330/1

x M*

0413/4/SP

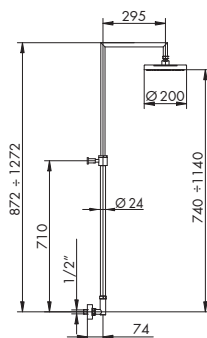

STELO DOCCIA

> stelo regolabile
> soffione orientabile Ø200 in ABS con anticalcare, per finiture diverse da cromo soffione in metallo
> ingresso inferiore da 1/2"

CROMATO

01-0413/4/SP

ALTRE FINITURE

XX-0413/4/SP

x M*

0513/4

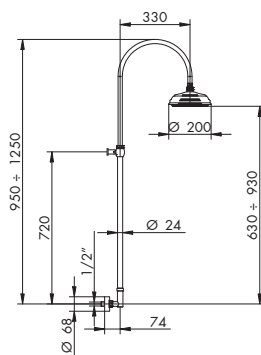

STELO DOCCIA C/SWAROVSKI

> stelo regolabile
> soffione orientabile Ø200 in ottone senza anticalcare
> ingresso inferiore da 1/2"

CROMATO

01-0513/4

ALTRE FINITURE

XX-0513/4

x M*

3313/4

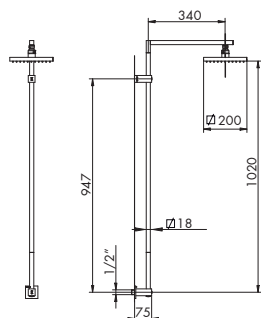

STELO DOCCIA C/SWAROVSKI

> stelo quadro fisso
> soffione orientabile 200x200 in ABS con anticalcare, per finiture diverse da cromo soffione in metallo
> ingresso inferiore da 1/2"
> supporti a muro con swarovski

CROMATO

01-3313/4

ALTRE FINITURE

XX-3313/4

x M*

6513/4

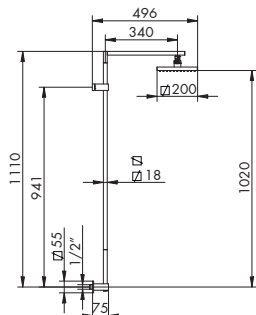

STELO DOCCIA

- > stelo quadro fisso
- > soffione orientabile 200x200 in ABS con anticalcare, per finiture diverse da cromo soffione in metallo
- > ingresso inferiore da 1/2"

CROMATO

01-6513/4

ALTRE FINITURE

XX-6513/4

x M*

8013/4

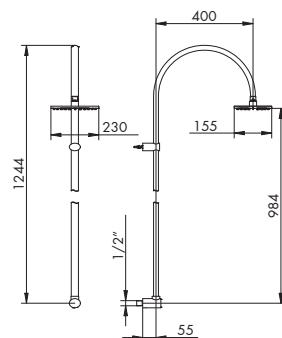

STELO DOCCIA

- > stelo ovale fisso
- > soffione orientabile 230x155 in ottone con anticalcare
- > ingresso inferiore da 1/2"

CROMATO

01-8013/4

ALTRE FINITURE

XX-8013/4

x M*

8313/4 | BIJOUX

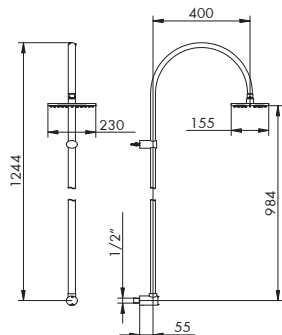

STELO DOCCIA C/SWAROVSKI

- > stelo ovale fisso
- > soffione orientabile 230x155 in ottone con anticalcare
- > ingresso inferiore da 1/2"
- > ovale inferiore con SWAROVSKI

CROMATO

01-8313/4

ALTRE FINITURE

XX-8313/4

x M*

0313/5/1

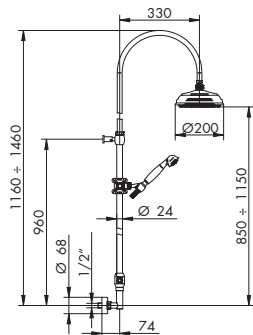

CURVA PRESA ACQUA C/STELO COMPLETO

- > stelo regolabile
- > deviatore a trazione c/ritorno automatico e blocco meccanico bassa pressione
- > soffione Ø200 in ottone senza anticalcare
- > flessibile in pvc 150 cm
- > supporto doccetta scorrevole
- > ingresso da 1/2"
- > maniglia a croce
- > Doccetta monogetto in metallo senza anticalcare manico in porcellana Ø52



035303
p. 212

CROMATO

01-0313/5/1

ALTRE FINITURE

XX-0313/5/1

x M*

0413/5/1/SP

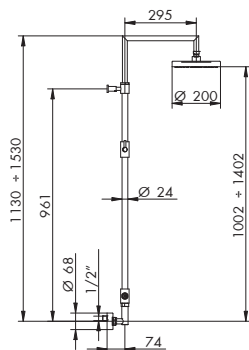

CURVA PRESA ACQUA C/STELO COMPLETO

- > stelo regolabile
- > deviatore a trazione c/ritorno automatico e blocco meccanico bassa pressione
- > soffione orientabile ø200 c/anticalcare
- > flessibile in ottone 150 cm
- > supporto doccetta scorrevole
- > ingresso da 1/2"
- > doccetta monogetto cilindrica in ABS c/anticalcare, per finiture diverse da cromo doccetta e soffione in metallo



045073
p. 212

CROMATO

01-0413/5/1/SP

ALTRE FINITURE

XX-0413/5/1/SP

x M*

0513/5/1

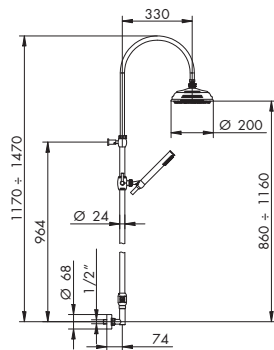

CURVA PRESA ACQUA C/STELO COMPLETO

- > stelo regolabile
- > deviatore a trazione c/ritorno automatico
- > soffione Ø200 in ottone senza anticalcare
- > flessibile in pvc 150 cm
- > supporto doccetta scorrevole
- > ingresso da 1/2"
- > doccetta monogetto cilindrica in abs c/anticalcare, per finiture diverse da cromo doccetta in metallo

035303
p. 212

CROMATO

01-0513/5/1

ALTRE FINITURE

XX-0513/5/1

x M*

0713/5/1

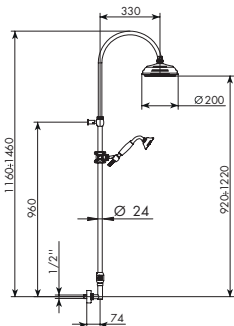

CURVA PRESA ACQUA C/STELO COMPLETO

- > stelo regolabile
- > deviatore a trazione c/ritorno automatico e blocco meccanico bassa pressione
- > soffione orientabile ø200 c/anticalcare
- > flessibile in pvc 150 cm
- > supporto doccetta scorrevole
- > ingresso da 1/2"
- > maniglia a croce
- > doccetta monogetto in metallo senza anticalcare manico in porcellana Ø77

035303
p. 212

CROMATO

01-0713/5/1

ALTRE FINITURE

XX-0713/5/1

x M*

0813/5/1

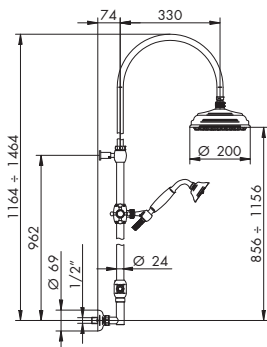

CURVA PRESA ACQUA C/STELO COMPLETO

- > stelo regolabile
- > deviatore a trazione c/ritorno automatico e blocco meccanico bassa pressione
- > soffione Ø200 in ottone senza anticalcare
- > flessibile in pvc 150 cm
- > supporto doccetta scorrevole
- > ingresso da 1/2"
- > maniglia a croce
- > doccetta monogetto in metallo senza anticalcare manico in porcellana Ø77

035303
p. 212

CROMATO

01-0813/5/1

ALTRE FINITURE

XX-0813/5/1

x M*

0813/5/1/L

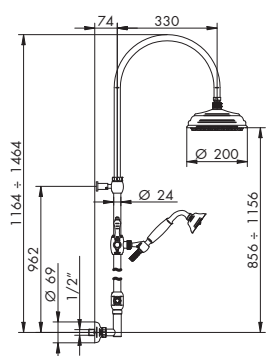

CURVA PRESA ACQUA C/STELO COMPLETO

- > stelo regolabile
- > deviatore a trazione c/ritorno automatico e blocco meccanico bassa pressione
- > soffione Ø200 in ottone senza anticalcare
- > flessibile in ottone 150 cm
- > supporto doccetta scorrevole
- > ingresso da 1/2"
- > leva con inserto in porcellana o legno
- > doccetta monogetto in metallo senza anticalcare manico in porcellana o legno Ø77

035303
p. 212

CROMATO

01-0813/5/1/L porcellana

01-0813/5/1/LL legno noce €

ALTRE FINITURE

XX-0813/5/1/L porcellana

XX-0813/5/1/LL legno noce €

x M*

x M*

1213/5/1

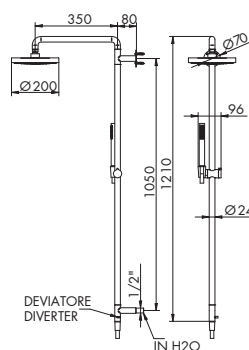

CURVA PRESA ACQUA C/STELO COMPLETO

- > stelo fisso
- > deviatore a leva
- > soffione orientabile Ø200 in ABS c/anticalcare
- > flessibile in PVC 150 cm
- > supporto doccetta scorrevole
- > attacco da 1/2"
- > doccetta monogetto cilindrica in ABS c/anticalcare, per finiture diverse da cromo doccetta e soffione in metallo

CROMATO

01-1213/5/1



3313/5/1

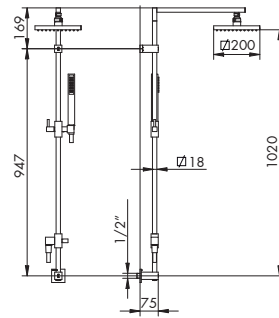

CURVA PRESA ACQUA C/STELO COMPLETO

- > stelo quadro fisso
- > deviatore a trazione con ritorno automatico e blocco meccanico per basse pressioni
- > soffione orientabile 200x200 in ABS c/anticalcare
- > flessibile PVC L 150 cm
- > presa acqua inferiore da 1/2"
- > supporti a muro con swarovski
- > doccetta monogetto quadra in ABS c/anticalcare, per finiture diverse da cromo doccetta e soffione in metallo

655070 p. 213

CROMATO	ALTRE FINITURE
01-3313/5/1	XX-3313/5/1 x M*

4013/5/1

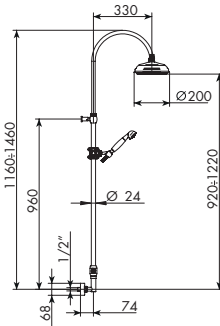

CURVA PRESA ACQUA C/STELO COMPLETO

- > stelo regolabile
- > deviatore a trazione c/ritorno automatico e blocco meccanico bassa pressione
- > soffione Ø200 in ottone senza anticalcare
- > flessibile in pvc 150 cm
- > supporto doccetta scorrevole
- > ingresso da 1/2"
- > maniglia a croce in porcellana decorata o bianca
- > doccetta monogetto in metallo senza anticalcare manico in porcellana Ø77

035303 p. 212

CROMATO	ALTRE FINITURE
01-4013/5/1 decorata	XX-4013/5/1 decorata x M*
01-4013/5/1/B bianca €	XX-4013/5/1/B bianca € x M*

6313/5/1

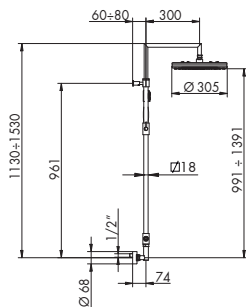

CURVA PRESA ACQUA C/STELO COMPLETO

- > stelo regolabile
- > deviatore a trazione c/ritorno automatico e blocco meccanico bassa pressione
- > soffione orientabile ø200 c/anticalcare
- > flessibile in pvc 150 cm
- > supporto doccetta scorrevole
- > ingresso da 1/2"
- > doccetta monogetto cilindrica in abs c/anticalcare, per finiture diverse da cromo doccetta e soffione in metallo

045073 p. 212

CROMATO	ALTRE FINITURE
01-6313/5/1-01 ins. in finitura € 1.507,00	XX-6313/5/1-XX ins. in finitura € 1.507,00 x M*
01-6313/5/1-66 ins. bianco op. € 1.507,00	XX-6313/5/1-66 ins. bianco op. € 1.507,00 x M*
01-6313/5/1-67 ins. nero op. € 1.507,00	XX-6313/5/1-67 ins. nero op. € 1.507,00 x M*

6513/5/1

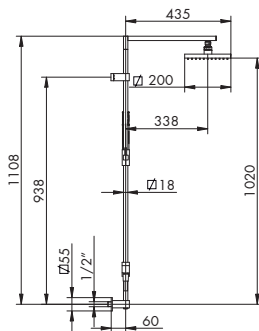

CURVA PRESA ACQUA C/STELO COMPLETO

- > stelo quadro fisso
- > deviatore a trazione con ritorno automatico e blocco meccanico per basse pressioni
- > soffione orientabile 200x200 in ABS c/anticalcare
- > flessibile PVC L 150 cm
- > presa acqua inferiore da 1/2"
- > doccetta monogetto quadra in ABS c/anticalcare, per finiture diverse da cromo doccetta e soffione in metallo

655070 p. 213

CROMATO	ALTRE FINITURE
01-6513/5/1 € 1.897,00	XX-6513/5/1 € 1.897,00 x M*

7513/5/1

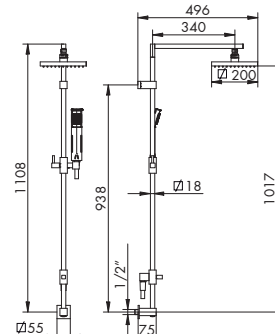

CURVA PRESA ACQUA C/STELO COMPLETO

- > stelo quadro fisso
- > deviatore a trazione con ritorno automatico e blocco meccanico per basse pressioni
- > soffione orientabile 200x200 in ABS c/anticalcare
- > flessibile PVC L 150 cm
- > presa acqua inferiore da 1/2"
- > doccetta monogetto rettangolare in ABS c/anticalcare, per finiture diverse da cromo doccetta quadra e soffione in metallo (art. 6513/5/1)

655070 p. 213

CROMATO	ALTRE FINITURE
01-7513/5/1	XX-7513/5/1 x M*

9113/5/1/SP

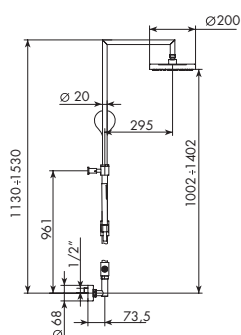

CURVA PRESA ACQUA C/STELO COMPLETO

- > stelo regolabile
- > deviatore a trazione c/ritorno automatico e blocco meccanico bassa pressione
- > soffione orientabile $\varnothing 200$ c/anticalcare
- > flessibile in pvc 150 cm
- > supporto doccetta scorrevole
- > ingresso da 1/2"
- > doccetta monogetto cilindrica in abs c/anticalcare, per finiture diverse da cromo doccetta cilindrica e soffione in metallo

045073
p. 212

CROMATO

01-9113/5/1/SP

ALTRE FINITURE

XX-9113/5/1/SP

x M*

1015/S

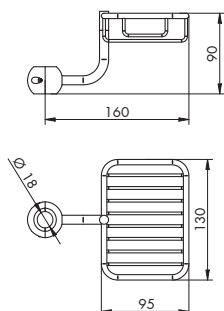

CESTINO PORTA SAPONE

- > attacco per asta $\varnothing 18$

CROMATO

01-1015/S

€

ALTRE FINITURE

XX-1015/S

€

x M*

0514

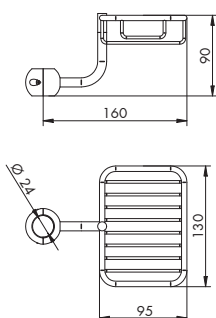

CESTINO PORTA SAPONE

- > attacco per asta $\varnothing 24$

CROMATO

01-0514

ALTRE FINITURE

XX-0514

x M*

654112

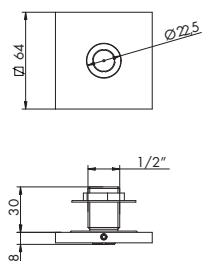

NEBULIZZATORE INCASSO

- > spray nebulizzatore
- > ingresso da 1/2"
- > rosone quadro

CROMATO

01-654112

ALTRE FINITURE

XX-654112

x M*

884067

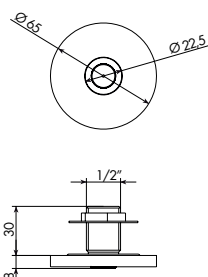

NEBULIZZATORE INCASSO

- > spray nebulizzatore
- > ingresso da 1/2"
- > rosone tondo

CROMATO

01-884067

ALTRE FINITURE

XX-884067

x M*



104038

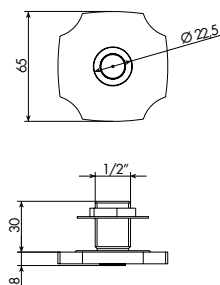

NEBULIZZATORE INCASSO

- > spray nebulizzatore
- > ingresso da 1/2"
- > rosone Classic

CROMATO
01-104038

ALTRE FINITURE
XX-104038

x M*

095001

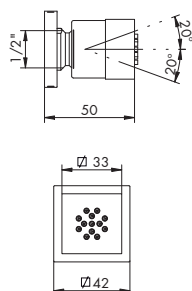

BODY-JET ORIENTABILE QUADRO ESTERNO

- > erogazione a getti
- > ugelli siliconici anticalcare
- > quadro
- > attacco da 1/2" femmina

CROMATO
01-095001

ALTRE FINITURE
XX-095001

x M*

055116

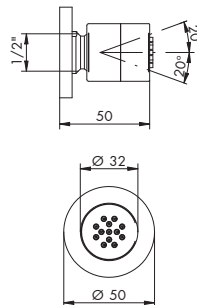

BODY-JET ORIENTABILE TONDO ESTERNO

- > erogazione a getti
- > ugelli siliconici anticalcare
- > tondo
- > attacco da 1/2" femmina

CROMATO
01-055116

ALTRE FINITURE
XX-055116

x M*

805001

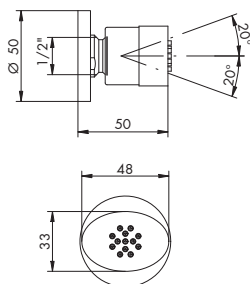

BODY-JET ORIENTABILE OVALE ESTERNO

- > erogazione a getti
- > ugelli siliconici anticalcare
- > ovale
- > attacco da 1/2" femmina

CROMATO
01-805001

ALTRE FINITURE
XX-805001

x M*

095039/E + 095040

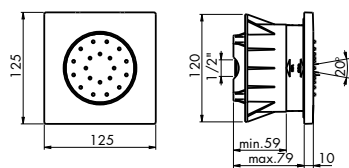

BODY-JET INCASSO ORIENTABILE QUADRO

- > parte incasso con B-Box
- > incasso minimo 59 mm
- > uscita singola effetto spray
- > getto orientabile 20°
- > rosone quadro

PARTI ESTERNE - CROMATO

01-095039/E

PARTE INCASSO

095040

PREZZO TOTALE



055251/E + 095040

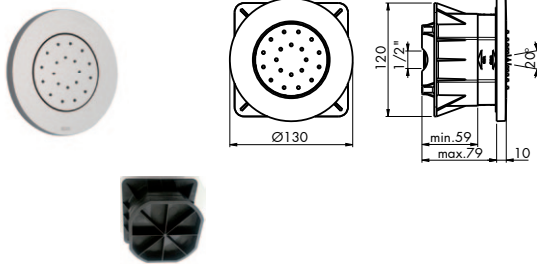

BODY-JET INCASSO ORIENTABILE TONDO

- > parte incasso con B-Box
- > incasso minimo 59 mm
- > uscita singola effetto spray
- > getto orientabile 20°
- > rosone tondo

PARTI ESTERNE - CROMATO

01-055251/E

PARTE INCASSO

095040

PREZZO TOTALE

7716/E + 775025

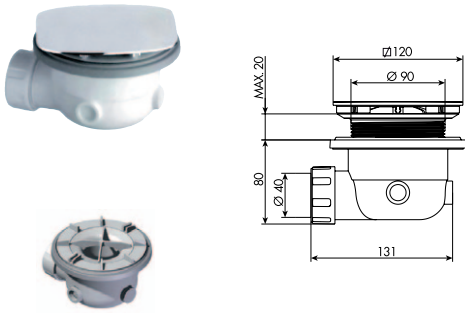

PILETTA PIATTO DOCCIA QUADRA

- > per piatto doccia foro Ø90
- > scarico quadro
- > 120x120

PARTI ESTERNE - CROMATO

01-7716/E

PARTE INCASSO

775025

PREZZO TOTALE

PARTI ESTERNE - ALTRE FINITURE

XX-7716/E

x M*

8816/E + 775025

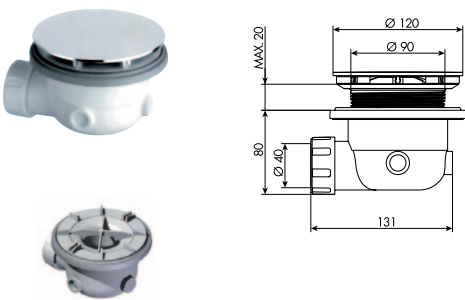

PILETTA PIATTO DOCCIA TONDA

- > per piatto doccia foro Ø90
- > scarico tondo
- > Ø120

PARTI ESTERNE - CROMATO

01-8816/E

PARTE INCASSO

775025

PREZZO TOTALE

PARTI ESTERNE - ALTRE FINITURE

XX-8816/E

x M*

8016/E + 775025

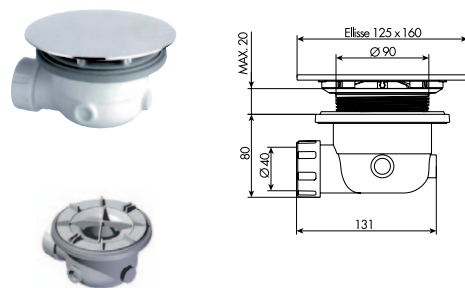

PILETTA PIATTO DOCCIA OVALE

- > per piatto doccia foro Ø90
- > scarico ovale
- > ellisse 125x160

PARTI ESTERNE - CROMATO

01-8016/E

PARTE INCASSO

775025

PREZZO TOTALE

PARTI ESTERNE - ALTRE FINITURE

XX-8016/E

x M*

016

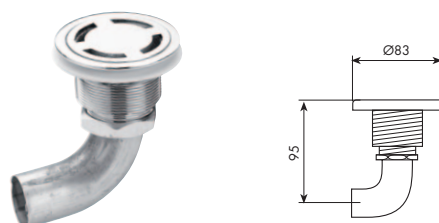

PILETTA A GRIGLIA PER SCARICO PIATTO DOCCIA

- > scarico a griglia
- > Ø83

CROMATO

01-016

ALTRE FINITURE

XX-016

x M*

014081

GANCIO ESTERNO DUPLEX

> supporto doccia snodato

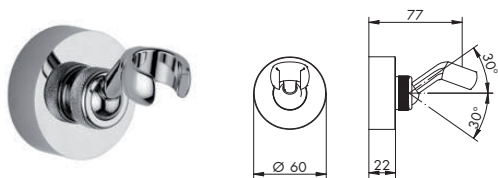

CROMATO

01-014081

ALTRE FINITURE

XX-014081

x M*

035102

GANCIO ESTERNO DUPLEX

> supporto doccia snodato



CROMATO

01-035102

ALTRE FINITURE

XX-035102

x M*

144023

GANCIO ESTERNO DUPLEX

> supporto doccia snodato

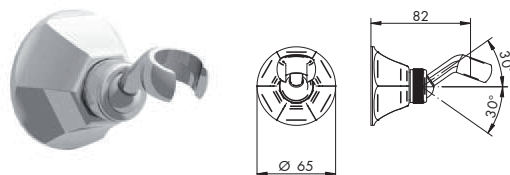

CROMATO

01-144023

ALTRE FINITURE

XX-144023

x M*

445005

GANCIO ESTERNO DUPLEX

> supporto doccia snodato



CROMATO

01-445005

ALTRE FINITURE

XX-445005

x M*

655005

GANCIO ESTERNO DUPLEX QUADRO

> supporto doccia orientabile

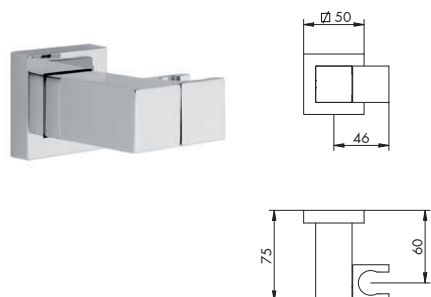

CROMATO

01-655005

ALTRE FINITURE

XX-655005

x M*

804019

GANCIO ESTERNO DUPLEX OVALE

> supporto doccia snodato

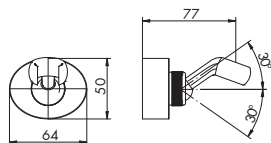
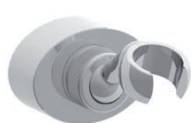

CROMATO

01-804019

ALTRE FINITURE

XX-804019

x M*

134011

SET COMPLETO DI ACCESSORI PER LA PULIZIA DOCCE

- > rullo manutenzione ugelli anticalcare al silicone
- > spatola pulizia bocche a lama
- > testina per manutenzione nebulizzatori
- > asta estendibile
- > panno in microfibra



SENZA FINITURA

134011

134012

FLACONE DETERGENTE

- > 50 ml
- > detergente non aggressivo anticalcare



SENZA FINITURA

134012

